

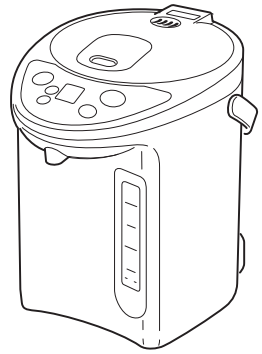

PDR-S30S
PDR-S40S

PDR-S



For household use

Electric Water Heater / Warmer

User Manual

Thank you for purchasing this product.
Read all the information in this user manual before using the appliance.
Keep this manual in a handy location for future reference.

家庭用

電熱水瓶

使用說明書

感謝您購買本公司產品。
請您在使用前，務必詳讀使用說明書，以便正確使用。
並請妥善保管本說明書。

家庭用

电热水瓶

使用说明书

非常感谢您购买本公司的产品，在您使用之前，
请仔细阅读完本说明书，并妥善保管，以便随时参阅。

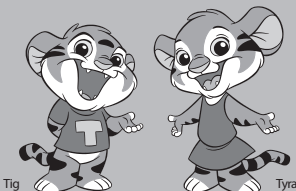

©2003 TIGER CORPORATION

English

Contents

| | |
|------------------------------------|----|
| 1 Important Safeguards | 3 |
| 2 Part Names and Accessories | 7 |
| 3 Boiling Water | 8 |
| 4 Dispensing Hot Water | 10 |
| 5 How to use Energy Saving Mode | 11 |
| 6 Using the Power-Saving Timer | 12 |
| 7 After Finishing Using the Heater | 13 |
| 8 Cleaning | 14 |
| 9 Troubleshooting | 16 |

中文

目錄

| | |
|---------------|----|
| 1 安全注意事項 | 19 |
| 2 各部的名稱與功能 | 23 |
| 3 煮水的方法 | 24 |
| 4 取用熱水的方法 | 26 |
| 5 節能功能模式的使用方法 | 27 |
| 6 節電定時的用法 | 28 |
| 7 使用後 | 29 |
| 8 保養方法 | 30 |
| 9 懷疑是故障時 | 32 |

中文

目录

| | |
|------------|----|
| 1 安全注意事项 | 35 |
| 2 各部件名称和附件 | 39 |
| 3 烧水 | 40 |
| 4 按出水键倒出开水 | 42 |
| 5 设定节能功能 | 43 |
| 6 设定省电计时 | 44 |
| 7 不使用时倒除开水 | 45 |
| 8 进行清洗 | 46 |
| 9 认为发生故障时 | 48 |

IMPORTANT SAFEGUARDS

When using the appliance, basic safety precautions should always be followed including the following:

1. Read all instructions.
2. Do not touch hot surfaces. Use handles or knobs.
3. To protect against electrical shock, do not immerse cord or plug in water or other liquid.
4. Close supervision is necessary when the appliance is used by or near children.
5. Unplug from outlet when not in use and before cleaning. Allow to cool before putting on or taking off parts.
6. Do not operate the appliance with a damaged cord or plug or after the appliance malfunctions or has been damaged in any manner. Return appliance to the nearest authorized service facility for examination, repair, or adjustment.
7. The use of accessory attachments not recommended by the appliance manufacture may result in fire , electric shock or injury to persons.
8. Do not use outdoors.
9. Do not let cord hang over edge of table or counter, or touch hot surfaces.
10. Do not place the appliance on or near a hot gas or electric burner, or in a heated oven.
11. Extreme caution must be used when moving the appliance containing hot oil or other hot liquids.
12. Always attach plug to the appliance first, then plug cord into the wall outlet.
To disconnect, turn any control to "off", then remove plug from wall outlet.
13. Do not use the appliance for other than intended use.

SAVE THESE INSTRUCTIONS

Servicing should be performed by an authorized service representative.

This appliance is intended for household use.

To reduce the risk of injury , do not drape cord over the counter top or table top where it can be pulled on by children or tripped over unintentionally.

The appliance is not intended for use by persons (including children) with reduced physical, sensory or mental capabilities, or lack of experience and knowledge, unless they have been given supervision or instruction concerning use of the appliance by a person responsible for their safety.

Children should be supervised to ensure that they do not play with the appliance.

The following instructions are applicable to 120V only:



This appliance has a polarized plug (one blade is wider than the other). To reduce the risk of electric shock, this plug is intended to fit into a polarized outlet only one way. If the plug does not fit fully into the outlet, reverse the plug. If it still does not fit, contact a qualified electrician. Do not attempt to modify the plug in any way.

1 Important Safeguards

Read and follow all safety instructions before using the appliance.

- ※ The WARNINGS and CAUTIONS described below are intended to protect the user and other individuals from physical harm and household damage. To ensure safety, please follow carefully.
- ※ Do not remove the caution/warning seal attached to the appliance.

Safety instructions are classified and described according to the level of harm and damage caused by improper use, as shown below.







| | |
|---|---|
|  | This symbol indicates there is a possibility of death or serious injury* ¹ when the unit is improperly handled. |
|  | This symbol indicates there is a possibility of injury* ² or damage* ³ to property when the unit is improperly handled. |

*1 "Seriously injury" is defined here as loss of sight, burns (high and low temperature), electric shock, broken bones, poisoning, or other injuries severe enough to require hospitalization or extended outpatient care.

*2 "Minor or moderate injury" is defined here as a physical injury, burn, or electric shock which will not require hospital stay or extended outpatient care.

*3 "Damage to property" is defined here as damage towards a building, furniture, or pets.

Description of Symbols

| | |
|---|---|
|  | The  symbol indicates a warning or caution. The specific details of the warning or caution are indicated inside the symbol or in an illustration or text near the symbol. |
|  | The  symbol indicates a prohibited action. The specific details of the prohibited action are indicated inside the symbol or in an illustration or text near the symbol. |
|  | The  symbol indicates an action that must be taken or an instruction that must be followed. The specific details of the action or instruction are indicated inside the symbol or in an illustration or text near the symbol. |

Extra attention must be paid when used in a household where infants or toddlers are present.

Warning



Do not allow children to use the appliance by themselves and do not put within reach of infants or toddlers. Failing to do so may result in burns, electric shock, or injury.



Do not let infants or children lick the electric sockets or fixtures.

Doing so may result in electric shock.



This appliance is not intended for use by persons (including children) with physical difficulties or lack of experience and knowledge - unless they have been given supervision or instruction concerning to the use of the appliance by a person responsible for his/her safety.



Attach the lid tightly until a "clicking" sound is heard.

If lid is not attached properly water may boil over or spill if tipped, which may cause scalds.



Do not touch

To avoid scalds, do not touch or allow your face to get close to the steam vent. Especially keep out of the reach of infants and toddlers.



Caution



Do not use on an unstable surface, or on a table or rug that is vulnerable to heat.

If the kettle tips over, water may spill, which may cause scalds. Fire or damage to the table or surrounding materials may result.

Warning



Disassemble is prohibited.

Do not attempt to disassemble, repair, or modify the product. Repairs should only be performed by a qualified service representative.

Doing so may result in fire, electric shock, or injury.



Use only rated voltage power.

Use of any other power supply voltage may result in fire or electric shock.



Use an electrical outlet rated 7A or higher and do not plug in other devices at the same time.

Connecting other devices in the same outlet may cause the outlet to overheat or result in fire.



Do not damage or use a damaged power cord. Do not forcefully bend, twist, fold, or modify the cord. Do not place near high temperature surfaces or under/between heavy objects.

A damaged power cord can cause fire or electric shock.



Wipe the plug thoroughly in the case dust or other foreign objects are collected.

This is to avoid fire.



Firmly insert the plug into the outlet to avoid electric shock, shorting, smoke, or fire.



Do not use the product if the power cord or plug is damaged or the plug is loose in the outlet. This is to avoid electric shock shorting, or fire.



If the supply cord is damaged, it must be replaced by a special cord or assembly available from the manufacturer or its service agent.



Do not touch the unit with wet hands.

Do not plug in or unplug with wet hands.

This is to avoid electric shock or injury.



Do not exceed the max water level mark level. If spillage or overflowing occurs, it could cause scalds.

If the water is lower than the refill mark, discoloration of the container or other problems may occur.



Do not attach the lid forcefully.

If spillage or overflowing occurs, it could cause scalds.



Do not block the steam vent with a cleaning cloth or other items.

This is to avoid scalds due to hot water spillage or deformation of the lid.



Do not insert or boil anything other than water.

Do not pour tea, milk, alcoholic beverages, tea bags, tea leaves, bincho charcoal, or instant food into the electric water heater / warmer. Doing so may create bubbles causing the contents to overflow. This may cause scalds, corrosion, malfunction or peeling of the fluoropolymer-coated surface.



Do not use as an ice cooler.

Cold water or ice may cause dew condensation, electric shock, or other problems.



Do not remove the lid while the water is boiling.

1 Important Safeguards

Warning



Do not hold the main unit close to your body, tilt or rock it, or shake vigorously.
Even if the dispense lock button is "locked," do not tilt or tip the product. This is to avoid scalds caused by spillage.



Do not tip over the product.
Even if the dispense lock button is "locked," do not tilt or tip the product. This is to avoid scalds caused by spillage.



Never immerse the unit in water or other liquid.

Do not immerse the appliance in water, or pour water into the appliance;
this is to avoid short circuits, electric shocks, and malfunctions.



Do not discard remaining hot water with the lid closed, this is to avoid scalds due to hot water spillage if the lid were to come off.

(Refer to p. 6,13 on how to discard remaining water)



If the lid gasket changes color or is damaged, be sure to replace it. If not replaced, water may spill if tipped over; possibly causing scalds.



Stop using the appliance immediately if you incur any malfunction or trouble. Not doing so may result in fire, electric shock, or injury.

Examples of trouble:

- The power cord and/or plug become abnormally hot.
- The power goes in and out when the power cord is moved.
- When the appliance becomes abnormally hot or there is a smell of something burning.
- Water leaks from the main unit.
- There are other problems or abnormalities.

Immediately unplug the power cord from the outlet and contact your local dealer for servicing.

Caution



Unplug the power cord.

Unplug power cord when not in use. This is to avoid injury, scalds, electric shock, or fire caused by a short-circuit.



Be sure to firmly hold the plug when removing from an outlet; this is to avoid electric shock, shorting, or fire.



Use only the power cord which is included with this product.

Do not use the included power cord with any other appliance.



Do not use multiple outlet receptacles, this is to avoid fire.



Do not use or place in areas prone to getting wet and do not allow the bottom of the main unit to get wet. This is to avoid shorting, electric shock, or malfunction.



Do not fill the water directly from the faucet or wet the bottom of the product.

Water may get into the product and cause shorting, electric shock, or malfunction.



Do not expose the plug to steam.

Doing so may result in electric shock or fire. When using the product on a sliding table, be careful not to expose the product to steam.

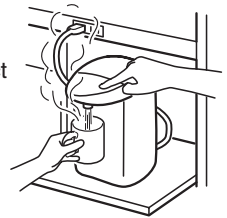

Do not use near the wall or furniture.

Steam or heat may damage the walls or furniture and cause discoloration or deformation.

When using the appliance on a kitchen rack or cabinet, make sure the steam or heat is not trapped.

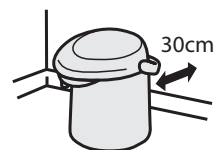

Caution



Do not touch

Do not come in contact with steam or condensation when opening or removing the lid, this is to avoid scalds.



Do not dispense hot water or do not move the main unit while the water is being boiled.

Hot water may splash or spill out, or steam may cause scalds.



Do not turn on the heater while dispensing hot water.

Hot water may splash or spill out, or steam may cause scalds.



Do not touch

Do not touch hot surfaces or the glass window during use or immediately after. This is to avoid burns.



When carrying the main unit, do not touch the close/open lever or the lid.

The lid may come off, and cause injuries or scalds.



Wait until the appliance has cooled down before performing maintenance;

this is to avoid burns from hot surfaces.



Before cleaning, be sure to remove the plug from the outlet, then remove from the appliance. When cleaning is complete, be sure to check that both ends of the power cord are dry before plugging in. Do not move the appliance when plugged in. Doing so may result in shorting, electric shock, or fire.



When discarding remaining water, be sure to discard in the direction shown in the following illustration.

If discarded from another location, water may get inside the main unit and cause scalds or malfunction.

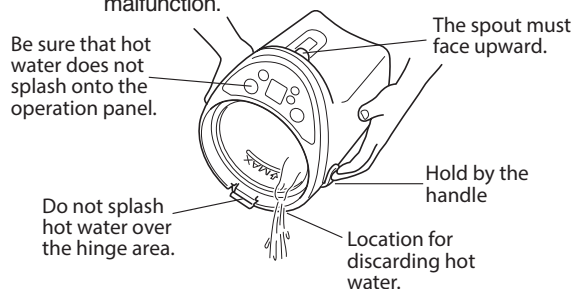

Do not wash the entire appliance. Do not pour water into the appliance or into the base of the appliance; this is to avoid short circuits and electric shocks.



Do not place the main unit upside down. This is to avoid malfunction.

Moisture or water drop leak into the unit caused a malfunction.



This appliance is intended to be used in household and similar applications such as:

- staff kitchen areas in shops, offices and other working environments;
- farm houses;
- by clients in hotels, motels and other residential type environments;
- bed and breakfast type environments.



Position the lid so that steam is directed away from the handle.

Following these safety instructions will allow the appliance to be used for many years.

Do not use near an open flame. This is to avoid deformation or malfunction.

Do not use in areas exposed to direct sunlight for a prolonged period.

The product may become hot and malfunction.

Do not turn on the electric water heater / warmer without water inside.

Turning the heater on with out water may cause the inner container to discolor or malfunction.

Do not put charcoal such as Bincho charcoal into the container, this is to avoid malfunction or peeling of the fluoropolymer-coated surface.

When unplugging the appliance and storing it for an extended period of time in a location subject to freezing temperatures, make sure there is absolutely no water in the inner container.

2 Part Names and Accessories

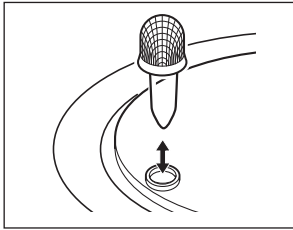
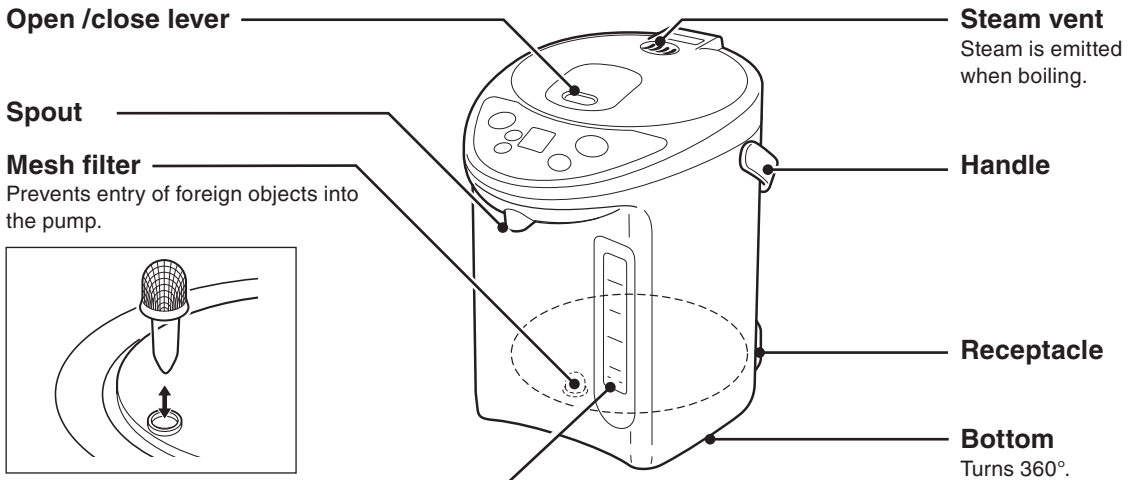

Water volume indicator

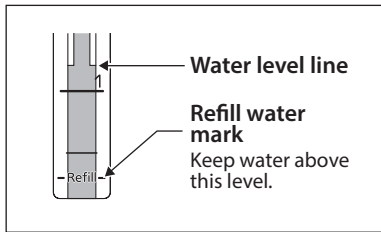

Caution Be sure the power cord is attached when you turn the swivel bottom.

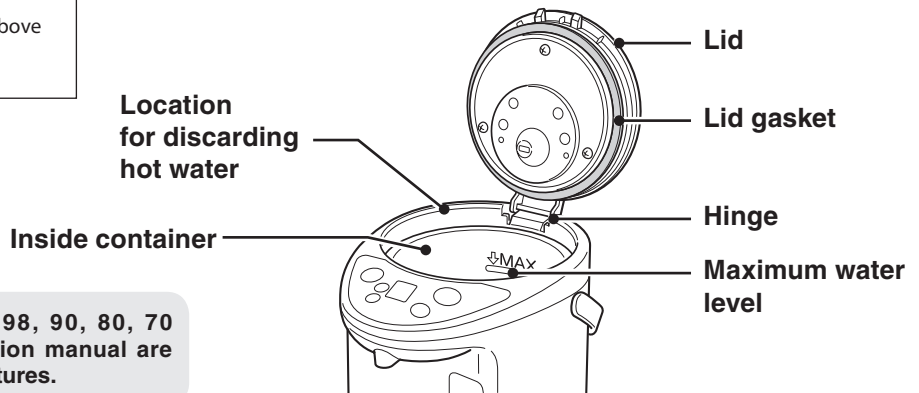

The numbers such as 98, 90, 80, 70 indicated in this instruction manual are only approximate temperatures.

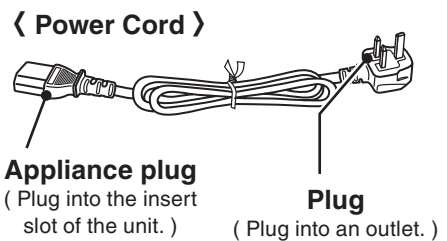
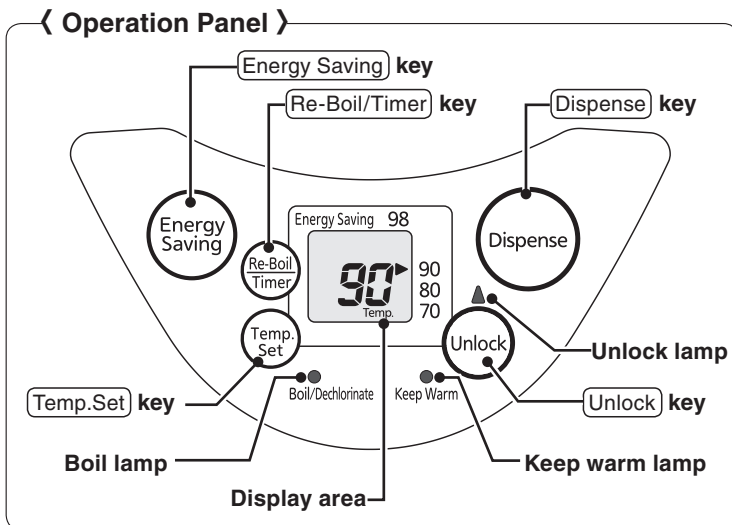

Sounds

When the water is being boiled, bubbling sounds can be heard from inside the container. This is normal and does not indicate a malfunction.

3 Boiling Water

Before first use / When not used for a while

Be sure to clean the unit before use. There may be a plastic smell when first used. This is normal and will diminish with use.

1. Add water to max water level and then bring up to boil. (See below)
2. After water is boiled, use electric dispenser button to discard half of hot water. (See p. 10)
3. Unplug the power cord, open the lid and then discard the rest of hot water. (See p. 16)

1 Open the lid.

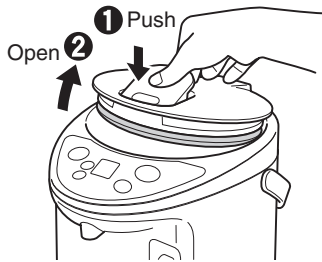

(((Sound)))

You may hear rattle sound when opening /closing the lid. There is a valve in the outer lid to prevent water spillage.

2 Pour water into the unit with a separate container.

Fill water to level between "Max water level" and "Refill water mark".

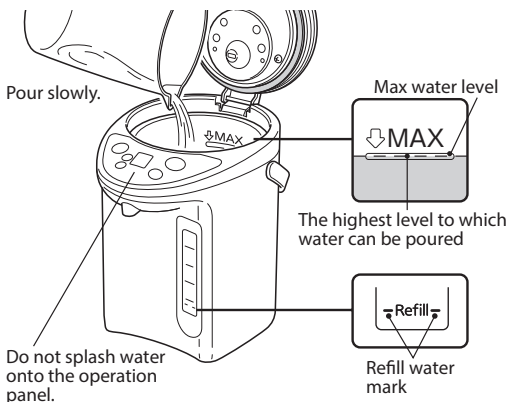

Caution

- Do not fill water directly from a faucet. Do not place the unit on wet surface.
- Automatic Boil cycle may not work when refilling hot water above 50°C, be sure to add lukewarm water or cold water or press **Re-Boil/Timer** key. (See p. 9)
- Do not exceed "Max water level". Do not boil water if the water level is lower than refill mark.

3 Close the lid.

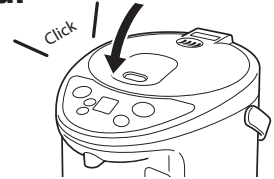

Caution

If the lid is not closed securely, hot water may spill and cause scaling.

4 Connect the power cord.

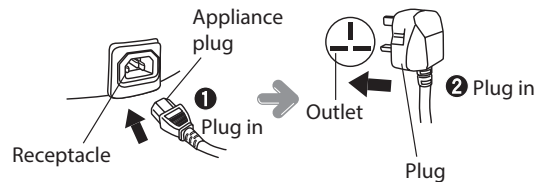

5 Boiling starts.

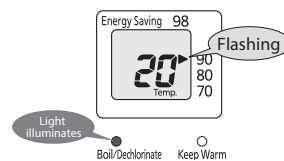

- ※ Refer to p. 9 when selecting the temperature for Warmer. (If no selection is made, a temperature of 90°C will be automatically set.)
- ※ Refer to p. 12 for setting the power-saving timer.

Eliminate chlorine smell

Press **Re-Boil/Timer** key once.

- ※ extend boiling time

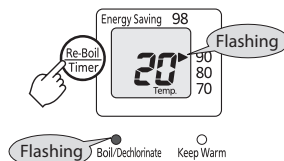

3 Boiling Water

6 Select [Keep Warm]

Press **Temp.Set** key.

Keep Warm temperature

98(approx.98°C), **90**(approx.90°C).

80(approx.80°C), **70**(approx.70°C).

Each press of **Temp.Set** key changes different temperature setting as shown.

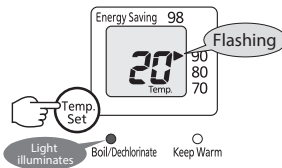

You can change temperature setting during Boiling cycle or Keep Warm.

Caution If the power cord comes off during the temperature setting, the setting is not completed. It will go back to default setting. (90)

During the boiling cycle

Current water temperature Remaining time until boiling

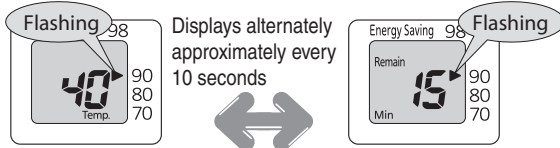

- ※ Timing to start displaying remaining time will vary depending on the amount of water and the water temperature.
- ※ Water temperature will be displayed by every 5°C. (If it is approximately 98°C, it will display "98".)

7 Automatically set to warmer

When boiling

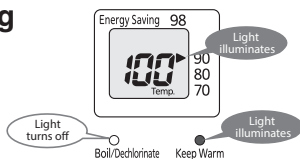

When water temperature reaches setting temperature...

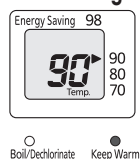

- Caution**
- Do not come in contact with the steam to avoid being scalded.
 - Do not open or close the lid with excessive force and do not dispense hot water during the boiling cycle or immediately after boiling. Failure to do so may cause scalds due to hot water splashing or steam being emitted.

Time table for Boiling and Cooling

| | 3.0L Type | 4.0L Type |
|---|-------------------------------|-------------------------------|
| Boiling from cold water | Approx.30 minutes | Approx.40 minutes |
| From boiling to reach 90 warmer temperature | Approx. 55 minutes | Approx. 1 hour and 5 minutes |
| From boiling to reach 80 warmer temperature | Approx. 1 hour and 45 minutes | Approx. 1 hour and 55 minutes |
| From boiling to reach 70 warmer temperature | Approx. 3 hour and 5 minutes | Approx. 3 hour and 25 minutes |

- ※ Under these conditions: full water volume, the water temperature / room temperature is 23°C, and voltage is normal rated voltage.
- ※ Guidelines for the time required to reach the 98 warmer temperature are almost the same as those for boiling from cold water.

To re-boil during the Keep Warm cycle. Press [Re-Boil/Timer] key once.

Be sure the water level is above Refill water mark.

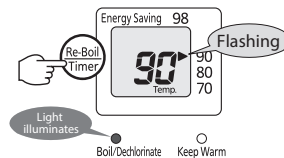

Guidelines for the time required for re-boiling when the water is at the full water level

| | 3.0L Type | 4.0L Type |
|------------------------------|----------------------|----------------------|
| Warmer temperature at 98, 90 | Approx.5-10 minutes | Approx.5-11 minutes |
| Warmer temperature at 80 | Approx.10-12 minutes | Approx.12-14 minutes |
| Warmer temperature at 70 | Approx.14-16 minutes | Approx.17-19 minutes |

- ※ Adding water or reattaching the power cord during Boiling cycle, boiling time may extend.

To reduce chlorine smell during Keep Warm cycle.

Press the **Re-Boil/Timer** key twice.

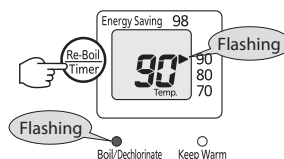

Press **Re-Boil/Timer** key and scroll through the option until you reach your preferred option cycle.

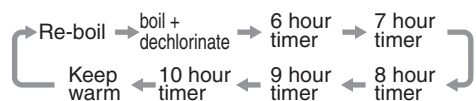

- ※ Be sure to check the display panel for your preferred cycle. It uses both **Re-Boil/Timer** key and [Power-Saving Timer]

4 Dispensing Hot Water

1 Press the **Unlock** key once.



2 Press the **Dispense** key.

Place a container under the spout, and press the

Dispense key.

Hot water continues to dispense while pressing the

Dispense key.

- ※ After checking that hot water has stopped dispensing, remove the container from the spout
- ※ If the unit is unplugged, hot water cannot be dispensed.
- ※ When water is boiled, air pressures increases in the container so that the water dispenser may not produce a smooth water flow immediately after it is boiled. Release the air pressure by opening the lid and then dispense the water. Be cautious of steam.
- ※ Mineral deposits can build on the wall of the inner container, mesh filter or pump unit, causing water to not dispense.
- ※ If the **Dispense** key is not pressed for approx. 10 seconds after dispensing hot water, the unlock lamp will be turned off and the unit will lock automatically.



- Caution**
- Do not dispense when water level is at "Refill water mark". Hot water may splash when you dispense.
 - Pay close attention when dispensing hot water so as to not spin the entire unit around.

3 Press the **Unlock** key once.

The Dispense lever will be locked, and hot water cannot be dispensed even if the key is pressed.

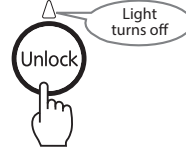

■ Refill water when level becomes low.

Be sure to refill water before it reaches [Refill water mark], and close the lid securely. (Caution for hot steam when refilling water. See p. 8)

- Caution** Do not leave the unit without any water inside, this is to avoid malfunction due to boiling without water.

5 How to use Energy Saving Mode

Energy Saving Mode applies to Boiling and Keep Warm cycles.

- Energy Saving Mode Boiling: heater will shut off when temperature reaches 98°C and reduce boiling steam. (Depending on the room and water temperature, the steam cut function may not work.)
- Energy Saving Mode cycle applies after 2 hours not in use. It reduces approximately 5°C from regular setting temperature e.g.: If you select 98, Energy Saving Mode is 95.

1 Select [Energy Saving Mode]

Press and hold [Energy Saving] key for a second.

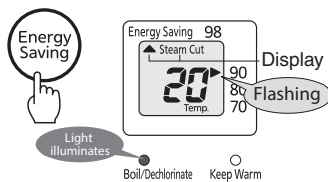

Disabling steam cut function for Energy Saving Mode cycle.

Boiling cycle with dechlorinate. (See p. 8)

2 Select [Keep Warm] (See p. 9)

3 Once water reaches boiling point, it automatically switches to Keep Warm mode.

When boiling cycle is done...

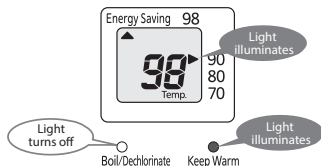

Water reaches setting temperature...

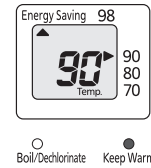

If the unit is not in use for 2 hours, it will automatically switch to Energy Saving Mode.

(5°C lower than regular setting temperature)

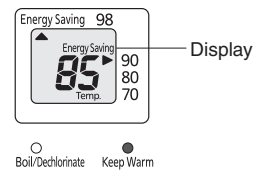

How to bring back to setting temperature.

Press [Temp.Set] or [Unlock] key once. Bring back to setting temperature about a minute.

How to cancel Energy Saving Mode

Press [Energy Saving] key for a second. (It automatically reheats when the temperature is low.)

Caution

Keep your face or other body parts away from the steam vent which may be hot during Energy Saving Mode boiling cycle.

6 Using the Power-Saving Timer

Power-Saving timer can be set in 1 hour intervals from 6 to 10 hours. You can set the timer before going to sleep or before going out. The power is turned off while using the energy saving timer. When the time is up, the unit will automatically reheat.

Press **Re-Boil/Timer** key and select energy saving hours

Be sure to check the status on the display.

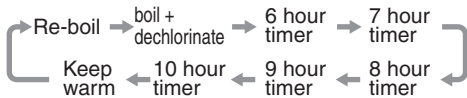
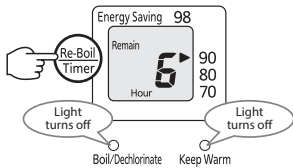

※ Remaining time will be displayed on an hourly basis until one hour before the Power-Saving Timer completes the operation.

■ The unit will start to boil 1 hour before

The unit will start to boil 1 hour before the completion of the timer; the display will show 59 minutes counting down to 1 minute.

■ After boiling, keep warm at setting temperature.

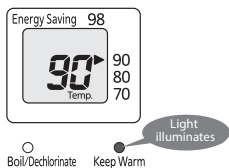

Caution Electric Dispenser does not work while Power-Saving Timer is on.

How to Cancel the Timer

Press the **Re-Boil/Timer** key to turn the Boil lamp on.

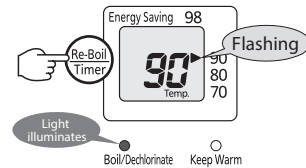

7 After Finishing Using the Heater

1 Unplug

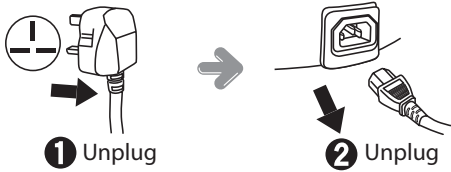

2 Remove the lid

While pressing down on the attach / remove lever for the lid, open and remove the lid by pulling the lid toward the spout.

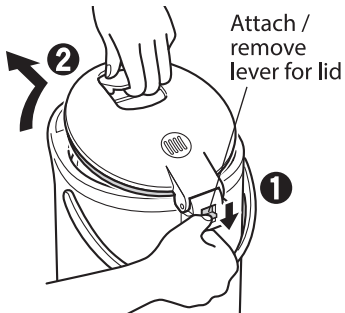

3 Discard remaining hot water (Refer to p. 6)

- Caution**
- Move the unit to the kitchen sink and then discard water slowly. Caution for hot water may splash during this operation.
 - Watch out for hot water dripping from the spout immediately after discarding the hot water.
 - Be sure to clean the inner container and mesh filter. (Refer to p. 14)

4 Attach the lid

While pressing down on the attach/remove lever for the lid, insert the hook-on part of the lid.

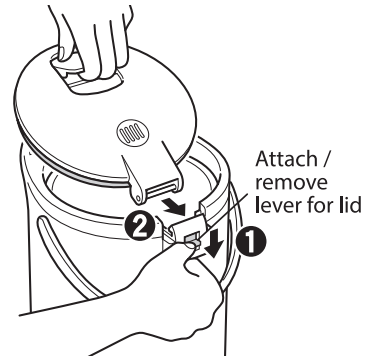



- Caution**
- Do not leave hot water remaining inside the container. This is to avoid discoloration of the inside container or foul odors from forming.
 - Do not turn the spout downward with the lid on, or discard hot water from the hinge area. This is to avoid scalds from splashing hot water or malfunction.
 - Pay extra attention when discarding the remaining hot water, as the mesh filter may fall if it is not properly attached.

8 Cleaning

Any other servicing should be performed by an authorized service representative.

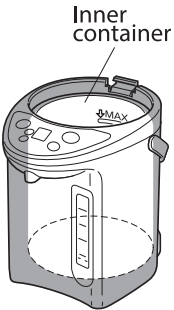
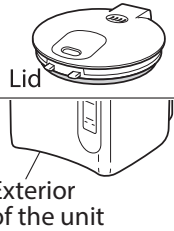
- **Unplug, discard remaining hot water, and wait until the unit cools down before cleaning can be started.**
- **Only use clean soft materials such as cloth, sponge, or paper towel.**

| Parts | Cleaning |
|---|---|
|  | <p>1 Simply rinse thoroughly with water and wipe the inside liner with a clean sponge or paper towel.</p> <div style="border: 1px solid black; padding: 5px;"> <p>Caution</p> <ul style="list-style-type: none"> To prevent damage to the water heater do not use alkaline cleaning agents when cleaning, use a soft cloth and a mild detergent. Do not use any material such as a cleanser or scrubber for tough stains or mineral deposit; this is to avoid damage to the non-stick (flouropolymer) coating surface. All water that contains minerals will leave mineral residue on the inside liner when boiled. If not cleaned for a prolonged period, mineral build up or stains may become tough or louder noises can be heard while boiling water. Frequent cleaning is recommended. Mineral deposit will eventually block the pipes and/or the steam vent if not removed. This blockage will cause the motor unit to burn when the "Dispense" key is pressed persistently. Do not scrub and/or do not use a knife to remove the mineral deposit. Discoloration caused by a dry boil is not removable. </div> <p>2 For mineral build up, use citric acid cleaner every 2-3 months (refer to p. 15)</p> <div style="border: 1px solid black; padding: 5px;"> <p>■ Uneven colors or discoloration of the inner container and floating white material in the water</p> <p>Red spots such as rust, milky white discoloration, black spots, iridescence that appear in the inner container, and floating white material are caused by a reaction of the minerals (calcium, magnesium, iron, etc.) contained in the water. This is not discoloration, rust, or peeling of the fluoropolymer-coated surface of the inner container itself. Although there are no sanitary / health concerns, frequent cleaning is recommended when the heater starts to show stains.</p> </div> |
|  | <p>Wipe off stains with a damp cloth or paper towel.</p> |
|  | <p>Wipe off with dry cloth.</p> |
|  | <p>Remove the mesh filter from inner container. Wash with soft brush e.g.: tooth brush.</p> <div style="border: 1px solid black; padding: 5px;"> <p>Caution</p> <ul style="list-style-type: none"> Frequent washing is recommended. This is to avoid clogging that may cause improper dispensing of hot water. After washing, be sure to attach the filter firmly to the inner container. If not attached, foreign objects may enter, causing the pump to stop dispensing. </div> |

Caution

- Do not soak the unit in water and do not pour water on the unit. This is to avoid shorting or electric shock.
- Never wash the entire unit. This is to avoid water getting inside the unit to cause malfunction.
- Do not use harmful materials such as detergent, thinner, cleanser, bleach, metal scrubber, nylon scrubber, and chemically-treated wiping cloths.
- Do not put in the dishwasher or dish dryer. This is to avoid deformation.

8 Cleaning

How to remove mineral deposit with citric acid

Caution When washing the inner container with citric acid, be sure to follow the directions below. This is to avoid hot water spills or scalds.

- Do not fill with hot water. Be sure to wash with cold water.
- Do not fill with water above the full water level.
- Do not open the lid during cleaning cycle.
- Be aware of hot steam during cleaning cycle.

※ Other functions are not available during cleaning cycle.

Citric acid can be purchased by contacting the Tiger product retailer where the heater was purchased, specifying product number PKS-0120 "citric acid (approx. 30g x 4 packs) for cleaning the inner container of the electric heater".

※ Citric Acid is used as natural food preservative. It is not harmful to your health.

■ < 90 minutes citric acid cleaning using QUICK function > For soft water (The guideline is once every 2-3 months)

- 1 Be sure that the mesh filter is set in the inner container.
- 2 Fill with cold water into the water heater up to the full water level capacity mark.
- 3 Add 1 package of PKS-0120 (30g / 2-3 tablespoons) citric acid powder into the water heater and mix a little.
- 4 Close the lid and plug in and keep pressing the **Temp.Set** key and the **Re-Boil/Timer** key at the same time for about 3 seconds.

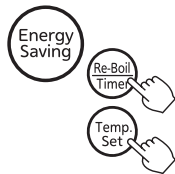

At the same time for about 3 seconds.

Washing will start. While the unit is being washed, the boiling lamp and the warmer lamp will alternately flash, notifying that washing is underway with the display panel changing as shown below. It will then switch to display the remaining washing time.

(Cleaning Time: 1 hour and 30 min)

※ cleaning hour may vary depending in the water temperature.

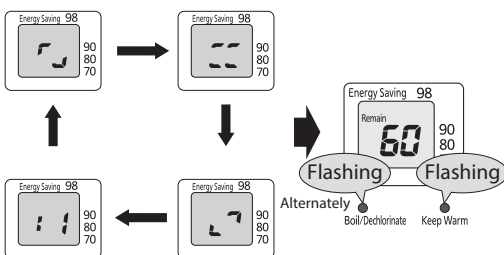

- 5 When washing is finished, the boiling lamp and the warmer lamp will illuminate.

The display panel will indicate as follows:

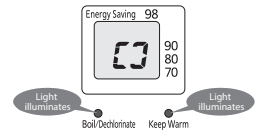

- 6 Discard all of the hot water (citric acid water) using **Dispense** key through the spout.
- 7 Unplug and discard the hot water. If stains remain, scrub with a sponge and rinse well with water.
 - ※ If mineral deposit is still attached on the wall of inner container, repeat the cleaning process.
- 8 To rinse remaining citric acid, refill with clean water and bring up to boil. Then discard half of water using **Dispense** key, open the lid discard rest of water.

Caution If you like to stop cleaning cycle, unplug the power cord. Be sure to discard citric acid water before using it again.

■ < 8 hours citric acid cleaning using 98 temperature setting > For hard water

Do not use the Quick cleaning function.
(The guideline is once every 15-30 days)

- 1 Be sure that the mesh filter is set in the inner container.
- 2 Fill with cold water into the water heater up to the full water level capacity mark.
- 3 Add 1 package of PKS-0120 (30g / 2-3 tablespoons) citric acid powder into the water heater and mix a little.
- 4 Close the lid and plug in and select 98 temperature setting.
- 5 Leave it at least 8 hours or overnight.
- 6 Press the **Dispense** key and have 1 / 3 of the water be discarded from the spout.
- 7 Unplug the water heater and remove the top lid to toss the remainder of the water. (See p. 6 diagram for the discarding location of hot water)
 - Note: Please use necessary caution when disposing hot water, it might cause burns or to scald.
- 8 Rinse off the inner container then wipe off any residue by using a soft sponge / cloth / paper towel. Assert caution when wiping the inner container as it is hot; allow it to cool down a little.
 - Note: If mineral build up persists, repeat the process.
- 9 To remove the smell of citric acid, boil only water as usual and dispense approximately half of the hot water through the spout and discard the rest of the water.

If not using for a prolonged period

- 1 Clean each part in accordance with the directions on p. 14, and wipe with a dry cloth.
- 2 Dry each part. (The inside container must particularly be thoroughly dried.)
- 3 Place in a plastic bag, etc., and store sealed.

Caution If storing, be sure to tightly seal in a plastic bag, etc., so that no bugs or dust can get in.

9 Troubleshooting

Check the following before asking for a repair.

| Symptom | Check | Action | Reference page |
|--|--|--|----------------|
| Water does not boil. (All the lamps are off and blank on display panel.) | Is the plug connected? | Connect the plug. | 8 |
| Does not start to boil after refilling the water. (Boil light does not lit) | Has the container been filled with hot water hotter than approx. 50°C? | Refill with either cooled water or cold water. | 8 |
| | | Bring the water to a boil by pressing the (Re-Boil/Timer) key. | 9 |
| Hot water comes out on its own. | Is the water level above the "Max water level?" | Keep water below the "Max water level." | 8 |
| There is a rasping sound when water is being boiled. | It is the sound of bubbles bursting which are generated by the water being boiled, and it does not indicate a problem. | | 7 |
| | Did you select Energy Saving Mode cycle? Selecting other cycle during Energy Saving Mode, re-boil starts automatically. You may hear a boiling sound. | | 11 |
| The sound of boiling seems louder than usual. | Is the inner container dirty? | Wash the inner container with citric acid. | 15 |
| Does not boil. (No steam) | Did you select Energy Saving Mode? Boiling will stop when temperature reaches approx.98°C to reduce the boiling steam. | Select boiling cycle with dechlorinate. | 8-9 |
| | Did you select Re-boil cycle? Re-boil cycle programmed to stop boiling below the boiling point. | | - |
| The hot water smells. | Depending on the amount of disinfectant chlorine in the tap water, the chlorine smell may remain. | Select boiling cycle with dechlorinate. | 8-9 |
| | Did you select Energy Saving Mode? Boiling will stop when temperature reaches approx.98°C to reduce the steam. | | |
| | Although there may be a smell of plastic or other materials for the first several times, they become less noticeable with use. | | - |
| | Did you place the unit on plastic tray or vinyl sheet? Water may absorb the resin smell. | | - |
| The exterior of the unit is hot. | If the unit is kept warm in a room with a high temperature, the exterior of the unit may become hot. This is not unusual. | | - |
| The inner container is dirty. White material is floating in the hot water. | This is caused by a reaction of the minerals contained in the water, and it is not discoloration, rust, or the peeling of the fluoropolymer surface on the inner container itself. | Clean the unit with Citric Acid. | 15 |
| The water is not hot enough. | Did you select Energy Saving Mode? | Press (Temp.Set) or (Unlock) key. Bring up to setting temperature in a minute. | 11 |
| | The first cup of hot water may not be very hot, because the water stored in the water pipe of the water volume indicator comes out first. | | - |
| Water does not dispense using electric dispense key. | Was hot water dispensed while the unit was tilted? | Place the unit completely upright. | - |
| | Is the plug connected? | Connect the plug. | 8 |
| | Is it set to lock automatically? | Press the (Unlock) key once to dispense hot water. | 9 |
| | Is it immediately after the water has boiled? | Open the lid once while watching out for steam. | |

9 Troubleshooting

| Symptom | Check | Action | Reference page |
|--|---|--|----------------|
| Water does not dispense using electric dispense key. | Are the mesh filter or the inside pump dirty? | Clean the unit with Citric Acid. | 15 |
| Display panels are fogged up. | Was the unit placed in an area prone to become wet or an area where the bottom can get wet? | Discard water, unplug, and leave until the panels are clear. If you still have cloud in the water scale, please contact customer service. | - |
| | Has the unit been placed upside down? | | |
| | When refilling with water, was water splashed onto the operation panel? | | |

Display Messages

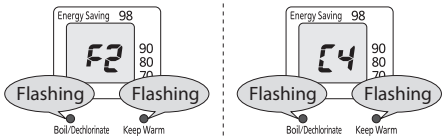
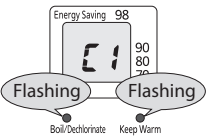
| Symptom | Check | Action | Reference page |
|---|---|---|----------------|
| <p>The unit is equipped with Dry-Boil Protection. Boil lamp and Keep Warm lamp flash alternately and signs (as shown) appear on the display.</p>  | Is there no water or very little water in the container? | Unplug, and refill to above the refill level of the water volume indicator. Leave as is for a while, then plug in. | 8 |
| | Has the unit been left for a prolonged period after all of the hot water was dispensed, or has lid been left open while refilling with water? | | |
| | When refilling, is water being poured with excessive force? | Unplug, leave for a while, then plug in. | |
| <p>Boiling Lamp and Keep Warm Lamp flash alternately will appear on the display as shown on right.</p>  | - | When refilling or cleaning the heater, water may get inside the unit and cause problems. Request repair work from the Tiger product retailer where the appliance was purchased. | - |

Specifications

| | | 3.0L Type | 4.0L Type |
|--|---|-------------------------|-----------|
| Capacity | | 3.0L | 4.0L |
| Power source | | AC 220 - 230V (50/60Hz) | |
| Power consumption | Electric power for boiling water | 682-745W | |
| | Electric power for the warmer | 65-71W | |
| Exterior size (approximate) (with the handle pushed down) | Width | 21.2cm | |
| | Depth | 28.0cm | |
| | Height | 29.4cm | 34.4cm |
| Weight (approximate) (including power cord) | | 2.3kg | 2.5kg |

※ Specified functions cannot be guaranteed in some areas (high altitude, extremely cold regions, etc.) Avoid using the unit in such locations.

Where to buy replacement parts and accessories.

Contact customer service

Gaskets (Consumer replaceable parts)

We recommend replacing the gasket annually or following these cases:

- Color changed to white.
- Any deterioration, spots become bigger.
- Steam coming out from gaps on the side.

| | |
|-------------------|----------------|
| Parts code | PDA1090 |
|-------------------|----------------|

Resin parts

Resin parts may deteriorate over time due to contacting heat and steam. Replacement lid is purchase separately.

Mesh filter (consumer replaceable parts)

- Attach mesh filter when cleaning the unit with citric acid. If mineral deposit is not removed, please purchase new one.

| | |
|-------------------|----------------|
| Parts code | PVH1184 |
|-------------------|----------------|

How to replace lid gasket

How to remove

1 Unfasten the screws

2 Remove lid gasket

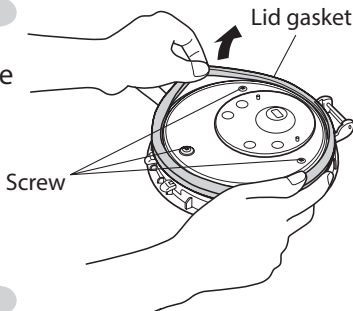

How to attach

1 Insert the lid gasket on to inner cover in proper position.

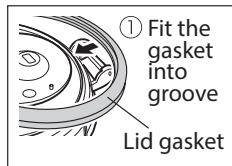
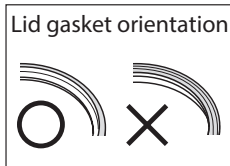

2 Run fingers around inner cover to press in to groove

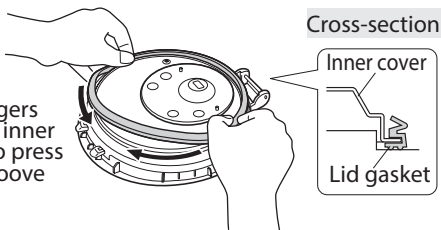

Be sure the gasket is attached properly.

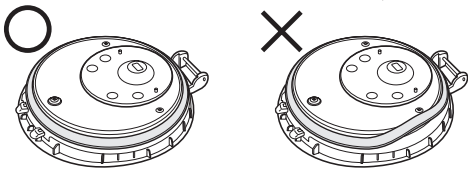

2 Attach 3 screws securely.

Caution

- ◆ Do not remove inner cover from lid. Improper setting can cause steam leakage and hot water will not dispense. If inner cover comes off, reattach the parts as shown below.

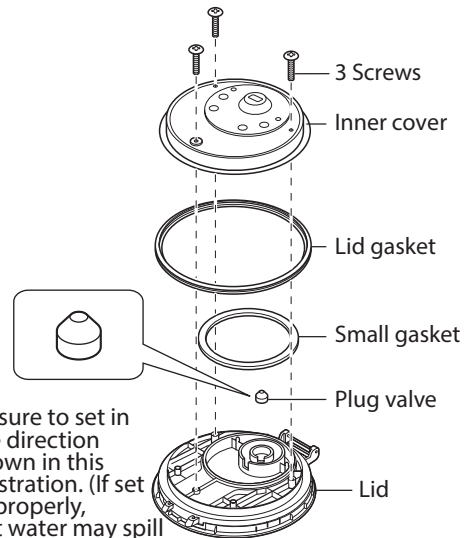

Be sure to set in the direction shown in this illustration. (If set improperly, hot water may spill and cause scalds.)

Replacing parts for the lid should only be done by a qualified technician. Please contact your local distributor or Tiger directly.

1 安全注意事項

使用前請仔細閱讀並遵守。

※此處所顯示的注意事項旨在防止對使用者或他人造成人身傷害或財產損害。屬於有關安全方面的重要內容，請務必遵守。

※請勿撕下產品上所黏貼有關注意事項的貼紙。

透過以下內容，將因疏忽注意事項而錯誤操作，導致危害及損害的程度，加以區分說明。



警告

表示假設操作不當時，可能導致使用者死亡或重傷^{*1}的內容。



注意

表示假設操作不當時，可能會造成使用者受到傷害^{*2}，或者出現財物損害^{*3}的內容。

*1 所謂重傷是指由於失明、受傷、燙傷（高溫、低溫）、觸電、骨折、中毒等留下後遺症，以及需要住院治療甚至長期複診的情況。

*2 所謂傷害是指不需要入院治療或長期複診的燙傷或觸電等情況。

*3 所謂物質損害是指波及到建築物、家產以及家畜、寵物等的連帶損害。

所用圖形符號的說明



注意

△符號表示警告、注意。具體注意內容會在圖形符號裡或者旁邊以圖片或文字表示。



禁止

⊘符號表示該行為屬於禁止行為。具體禁止內容會在圖形符號裡或者旁邊以圖片或文字表示。



指示

●符號表示強制行為或指示行為的內容。具體指示內容會在圖形符號裡或者旁邊以圖片或文字表示。

在家中有嬰兒或初學走路的孩子使用本產品時，需要格外注意。



警告



請勿讓兒童單獨使用本產品，也不要讓在幼兒可觸摸範圍內使用。可能導致燙傷、觸電或受傷。



請勿讓身障人士或無法充分理解使用方法者單獨使用本產品。使用時必須要有可充分理解使用方法者在一旁確認後陪同使用。可能會導致燙傷、觸電或受傷。



禁止觸碰

請勿將臉或手靠近蒸氣孔。否則可能會導致燙傷。特別是注意不要讓嬰幼兒碰觸。



勿將本產品主體插頭含在口中。應小心不要讓嬰幼兒誤將產品主體插頭含在口中。可能會導致觸電或受傷。



請蓋緊上蓋直至聽到“噠”一聲。萬一傾倒或熱水溢出，則會導致燙傷。



注意



請勿在不穩定場所、耐熱性差的桌子、墊子或地毯上面使用。如果本產品傾倒且熱水流出，可能會導致火災或燙傷、或者導致桌面或墊子、地毯褪色/變形。

警告



禁止分解

不可改造。

請勿讓非本公司專業維修技術人員，對本產品進行分解或維修。可能會導致火災、觸電或受傷。



請勿使用額定電壓以外的電源。

可能會導致火災、觸電或故障。



請單獨使用額定 7A 以上的插座。

如果與其他器具併用，多孔插座可能出現異常發熱、燒熔等現象，可能會導致火災。



電源線如果出現破損，請勿繼續使用。此外，請勿破壞電源線。

(加工、過度彎曲、靠近高溫處、拉扯、扭動、捆束、重壓、夾入物體等) 可能會導致火災或觸電。



插座上如有灰塵附著，請仔細清除乾淨。

積塵或其他異物會吸收水氣，因而導致絕緣失效，可能會導致火災。



使用時請將電源線插頭完全緊密插入插座，不可有鬆動情況。

可能會導致插頭、插座燒熔、觸電、短路、冒煙或火災。



電源線或電源線插頭受損，或電源插座鬆動時，請勿繼續使用。

可能會導致觸電或短路、燒熔、火災。



若電源線損壞時，必須由製造廠或其服務處或具有類似資格的人員更換，以避免危險。



請勿用濕手觸碰

請勿在手潮濕的情況下插拔電源線插頭。

可能會導致觸電或受傷。



請勿超過滿水標示位置。

以免因熱水溢出而導致燙傷。另外，水量若少於給水記號時，容易導致容器內部變色及故障。



蓋上上蓋時請勿過度用力。

以免熱水溢出而導致燙傷。



請勿用抹布或其他物件蓋住蒸氣孔。

以免因熱水溢出導致燙傷或上蓋變形。



請勿放入清水以外的東西。

請勿將茶、牛奶、酒精飲料、茶袋、茶葉、備長炭、速食或調理包食品倒入本產品內。否則會產生氣泡並因滾燙液體溢出而導致燙傷。同時還可能造成本產品燒焦、腐蝕、出現功能異常或氟素塗層脫落。



請勿將本產品做為冰桶使用。

冷水或冰可能導致結霜、觸電或其他故障現象。



煮沸中，請勿打開上蓋。

卅

卅

1 安全注意事項

警告



移動或倒水時，請勿環抱本產品或使其傾斜、搖動或晃動。請勿只拿上蓋搬動。

即使給水解鎖鈕已「上鎖」，也請勿將其傾斜或傾倒，以免因熱水溢出而導致燙傷。



即使出水鎖定按鈕為「上鎖」狀態，也請勿傾斜或翻倒熱水瓶。這樣可以避免因為潑濺而造成燙傷。

會造成熱水流出或有燙傷的危險。



請勿沾濕

請勿用水浸泡或淋濕本產品。

否則可能導致短路、觸電或火災。



上蓋未取下前，請勿倒掉剩餘的熱水。以免上蓋脫落，熱水濺出導致燙傷。(剩餘熱水的倒出方法請參照P. 22 · 29)



若上蓋墊圈已變成白色或裂化損耗時，請進行更換。

否則，如本產品傾倒，熱水會流出，可能會導致燙傷。



發生異常或故障時，請立即停止使用。若繼續使用，可能會造成火災、觸電或受傷。

(異常、故障範例)

- 使用中電源線是否會異常發熱。
- 插上電源的電線是否扭曲。
- 溫度是否異常過高是否有燒焦味。
- 本體是否會漏水。
- 出現其他異常或故障。

請立刻拔下電源插頭，聯絡原購買店家進行檢查與維修。

注意



拔取插頭

不使用時，請將電源線插頭從插座上拔下。

防止由於短路而造成人身傷害，或因電源線材劣化，導致觸電、漏電或火災。



取下電源線時請務必握緊插頭。

否則可能導致觸電或短路，從而導致火災。



請勿使用非本產品專用的電源線，或將電源線轉到其他電器用品上使用。

以免造成故障或火災。



請勿使用延長線。

可能造成火災。



請勿在易受潮濕的地方使用或放置本產品，同時請注意勿將本產品底部弄濕。

否則會導致短路、觸電或故障。



請勿放在水龍頭下直接加水或浸濕本產品底部。

本產品一旦進水會導致短路、觸電或功能異常。



插頭請不要接觸到蒸氣。

可能引發火災、觸電。在活動式桌子上使用時，請勿在蒸氣可影響範圍內使用電源線插頭。

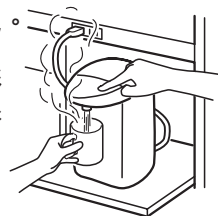

請勿在靠近牆壁或傢俱的位置使用。

使用過程中產生的蒸氣或高溫可能會損壞牆壁或傢俱，導致火災或褪色。使用廚房專用收納櫃等時，請注意切勿在蒸氣無法散發的環境中使用。

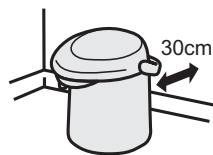

⚠ 注意



禁止觸碰

打開上蓋時請注意遠離蒸氣及水滴。
以免導致燙傷。



請勿在熱水沸騰時按壓出水，或移動本產品。
熱水可能會潑濺或灑出，或因蒸氣導致燙傷。



使用中請勿轉動本產品。
熱水可能會潑濺或灑出，或因蒸氣導致燙傷。



禁止觸碰

使用時或使用後請勿觸碰高溫表面。
可能導致燙傷。



移動本產品時，請勿觸碰開關閥。
可能因上蓋打開，導致受傷或燙傷。



待本產品冷卻之後再進行清潔保養。
高溫表面可能導致燙傷。



清洗前，請務必從插座上拔下插頭，並將裝置用插頭從本產品的插頭口拔下。清洗後重新使用時，需確認電源線的插頭、裝置用插頭及本產品插頭口已充分乾燥後，再插上各自的插頭。

請勿在插上電源時移動本產品。



請勿將本產品浸在水中，或向本產品沖水。請勿將本產品整體清洗。
以免造成短路、觸電、故障。



剩餘熱水要倒掉時一定要從下圖方向倒出。

如果從其他位置傾倒，熱水會進入本體內部而造成故障，也可能被燙傷。

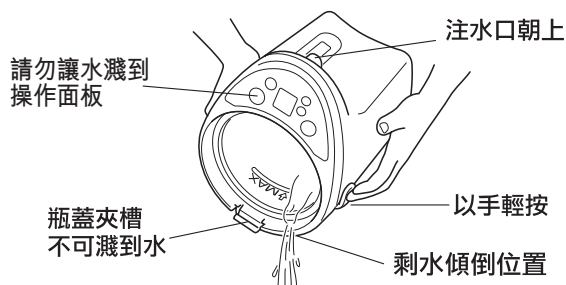

請勿將本產品倒立放置。

若底部有水，有可能會滲入本體導致功能異常。



本商品為一般家庭用，也可使用於下列所述場所。

- 店家或辦公室工作人員用廚房
- 農家
- 飯店、汽車旅館及其他住宿設施等



為了避免蒸氣外漏，請確實關緊上蓋。

為能永續使用，請務必遵守



請勿在火源附近使用。
可能導致變形或功能異常。



請勿在長時間暴露於太陽光直射下的地方使用。
可能會變熱，導致功能異常。



請勿空燒。
如瓶內沒水而通電時，可能造成內容器變色或導致故障。



請勿放入備長炭之類的炭。
可能導致故障、氟素加工剝落。



在拔除本產品電源，並長時間存放在可能達到冰點溫度的位置時，請確保容器內部絕無任何水份。

否則可能會因為水份凍結而造成故障。

2 各部的名稱與功能

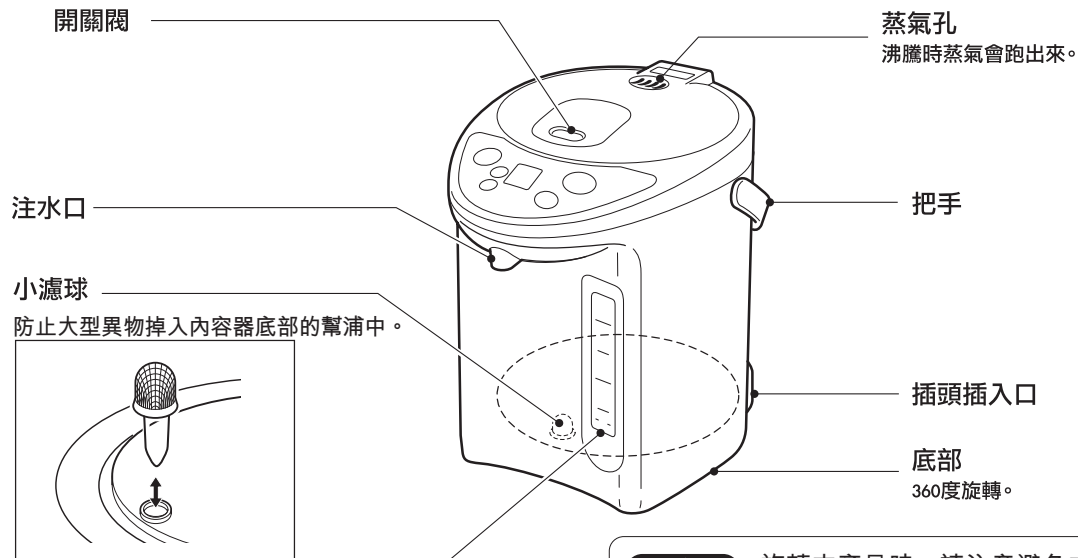

請注意 旋轉本產品時，請注意避免本產品端插頭脫落。

水量標示計

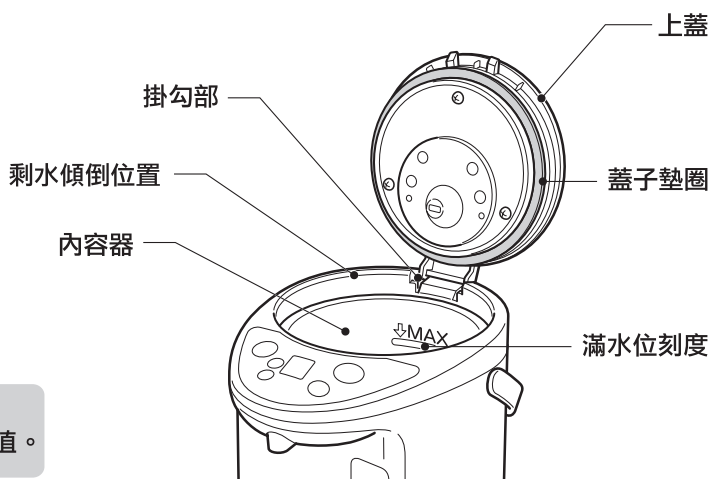
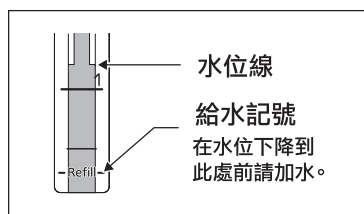

本使用說明書所記載的數值
98、90、80、70為保溫溫度的參考數值。

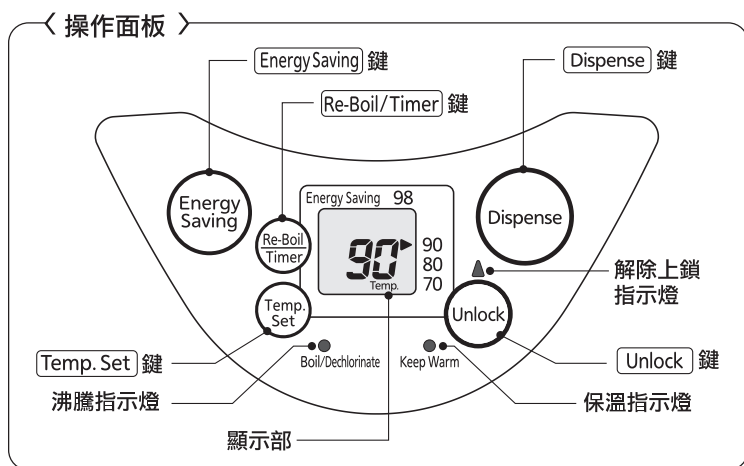

〈電源線〉



聲音提示

在煮水時會發出「咕嘟」的聲音，
那是在內容器產生的水泡迸裂之
聲響，並非故障。

3 煮水的方法

首次使用本產品或將本產品存放一段時間未使用時

請務必先煮水以清潔內容器。請依照以下步驟將沸騰的熱開水倒掉。前幾次使用時，樹脂和其他材料可能會散發出味道，但這會隨著使用增多而逐漸變淡。

- 1.請加水至滿水位，開始煮水。一請參照以下
- 2.水煮開後，用電動出水的方式壓出約半桶的水倒掉。一請參照 P. 26
- 3.拔除插頭，上蓋後將剩下的水倒掉。一請參照 P. 29

1 打開上蓋。



〔聲音〕 在開閉上蓋時，會發出「喀啦喀啦」聲，那是為了萬一翻倒防止熱水流出的氣閥音並非異常。

2 使用容器注入生水。

生水請注入到「給水記號」以上至「滿水位刻度」之間。

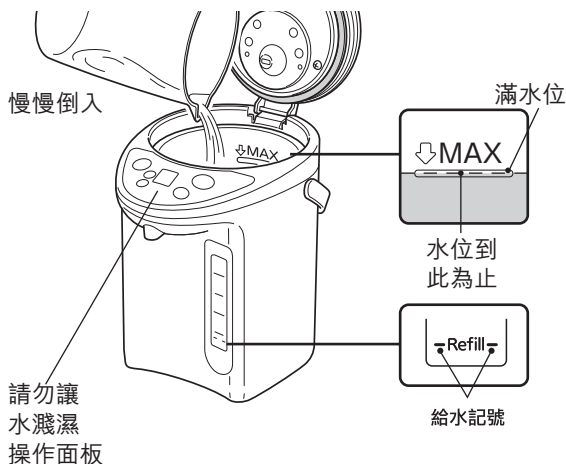

請注意

- 請勿從水龍頭直接加水，或將本體置放在潮濕的地方。底部請勿沾濕。
- 若加入約 50°C 以上的水，會造成無法自動煮水的情形，請加入冷水或讓水再次沸騰。(請參照 P. 25)
- 請勿將水加超過「滿水位」，或低於「給水記號」的水量煮水。

3 蓋上蓋子。



請注意 上蓋若沒有確實蓋上，翻倒時熱水會大量湧出，造成燒燙傷。

4 連接電源線。

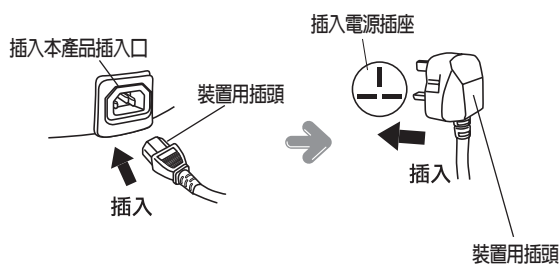

5 開始煮水。

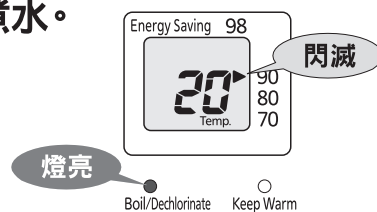

- ※要選擇保溫溫度時參照 P. 25。
(不選擇時會自動變成 90°C 保溫)
- ※設定節電定時器時參照 P. 28。

欲減少水中的氯氣味時

- 按一次 [Re-Boil/Timer] 鍵。
- ※會比正常煮水的時間長。

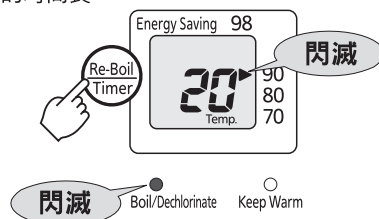

3 煮水的方法

6 選擇保溫

用 [Temp. Set] 鍵選擇。

■ 98(約98°C) • 90(約90°C) • 80(約80°C) • 70(約70°C)
溫度保溫時

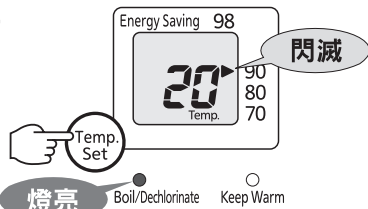

每按一次 [Temp. Set] 鍵將跳至下一個溫度。

煮水中或保溫中皆可變更保溫的溫度設定。

請注意 在設定中，如果插頭脫落，再度插上插頭時，會變成 90°C 保溫。

■ 煮水中...

現在水溫

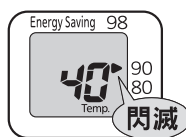

約每10秒
交替顯示

沸騰前剩餘時間

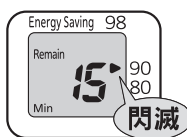

※沸騰前剩餘時間開始顯示的時機，因水量、水溫而不同。

※熱水溫度以每 5°C 顯示。(大約 98°C 時會顯示「98」)

7 自動保溫。

■ 煮沸時

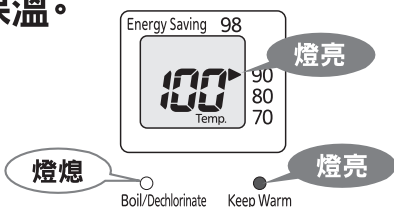

■ 降溫至設定的保溫溫度時

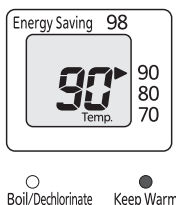

請注意

- 請勿觸碰蒸氣孔噴出的蒸氣，恐造成燙傷。
- 在煮水中或煮水後，請勿用力開閉上蓋或取用熱水，恐熱水飛濺或蒸氣孔噴出蒸氣，造成燙傷。

到達沸騰時間與自選保溫溫度 所需時間標準

| | 3.0L型 | 4.0L型 |
|---------|---------|---------|
| 生水到煮沸 | 約30分 | 約40分 |
| 煮沸到90保溫 | 約55分 | 約1小時5分 |
| 煮沸到80保溫 | 約1小時45分 | 約1小時55分 |
| 煮沸到70保溫 | 約3小時5分 | 約3小時25分 |

※水量: 滿水位、水溫: 室溫: 23°C、

電壓: 交流110V。

※生水煮沸到 98保溫的時間，大約和生水到煮沸的所需時間相同。

若在保溫中要再次煮沸時， 請按一次 [Re-Boil/Timer] 鍵。

請確認水量是否在給水記號以上。

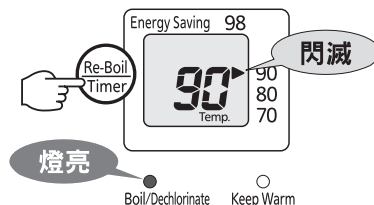

滿水位時再沸騰所需時間的基準

| | 3.0L型 | 4.0L型 |
|---------|---------|---------|
| 98·90保溫 | 約5~10分 | 約5~11分 |
| 80保溫 | 約10~12分 | 約12~14分 |
| 70保溫 | 約14~16分 | 約17~19分 |

※中途加水或重新插上電源插頭時煮水時間會變長。

※不同保溫溫度，直至沸騰的時間會不同。

■ 保溫中想減少熱水中的氯味時

按2次 [Re-Boil/Timer] 鍵，即開始再煮沸。

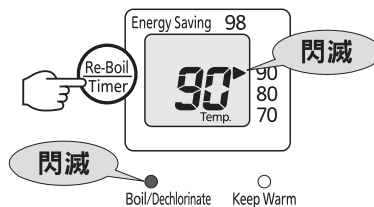

每按一次 [Re-Boil/Timer] 鍵將切換不同設定。

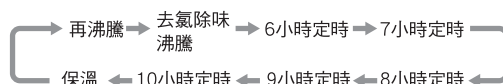

※ [Re-Boil/Timer] 鍵與節電定時鍵兼用，請對照液晶顯示部設定。

4 取用熱水的方法

1 按1次 **Unlock** 鍵。



2 按壓 **Dispense** 鍵。

將盛水容器放置注水口後按 **Dispense** 鍵。
按住時，從注水口會流出熱水。

- ※ 確定熱水出完後，將容器從注水口拿開。
- ※ 取下插頭後即無法給水。
- ※ 沸騰後所產生的氣泡會造成熱水不易出水。請小心蒸氣並打開上蓋後再蓋上上蓋按壓出水。
- ※ 內容器或小濾網、本體內部的出水管若有污垢，會造成不易出水的情形。
(請用檸檬酸洗淨清潔。→請參照 P. 31)
- ※ 取用熱水後，約10秒未按 **Dispense** 鍵，解除上鎖燈會熄滅，給水會被自動鎖住。

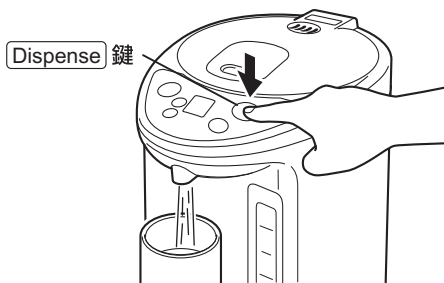

請注意

- 熱水量少時，請勿按壓出水。以免熱水飛濺噴出。
- 取用熱水時，請注意勿使本產品轉動，以免熱水溢出造成燙傷。

3 按1次 **Unlock** 鍵。

Dispense 鍵上鎖，即使按壓，也無法給水。



■ 若沒有水時，請務必加水。

水量接近「給水記號」時，請務必加水並蓋起上蓋。
(加水時請注意蒸氣。請參照 P. 24)

請注意

不要在無水空瓶狀態下插上電源，以免因空燒造成故障。

5 節能功能模式的使用方法

選擇節能功能模式時，可進行節能煮水及節能保溫功能。

- 節能煮水時，會在煮沸前關閉電熱器並進入減少蒸氣量的調整。煮水完成的溫度會控制在約98°C。(會依據室溫·水量·氣壓等條件不同，蒸氣量會有不同情形。)
- 使用節能保溫若2小時以上沒有使用時，設定溫度會降約5°C後持續保溫。(例如設定98°C保溫時，節能保溫會變成95°C持續保溫。)

1 選擇節能功能模式。

按住 [Energy Saving] 鍵，選擇節能功能模式。

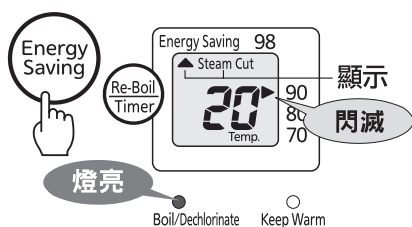

■ 節能功能模式 (讓水沸騰)

使用「去氯除味」模式煮水。(請參照 P. 24)

2 選擇保溫 (P. 25 參照)

3 煮水完成後將自動跳到保溫

■ 煮水完成後...

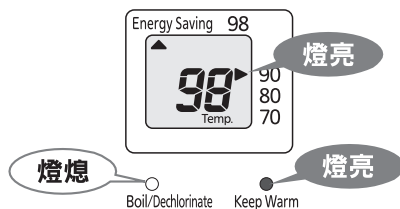

■ 降到設定的保溫溫度時...

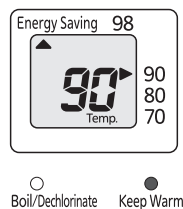

■ 2小時以上沒有使用時將自動切換到節能保溫模式
(設定溫度會降約5°C保溫)

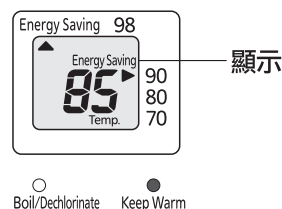

欲將節能保溫的水溫調回原先設定的溫度時

按住 [Temp.Set] 鍵或 [Unlock] 鍵約1分鐘，即可恢復至預設溫度。

欲解除節能功能時

按住 [Energy Saving] 鍵。
(水溫較低時，將自動煮水。)

請注意 節能煮水時，蒸氣孔仍為高溫。為避免燒燙傷，請勿觸摸或將臉靠近。

6 節電定時的用法

節電定時共有5個階段供選擇，可從約6小時後至約10小時後的每隔1小時時段做為設定。外出時或睡前設定節電定時，電熱器會自動關閉，進入保溫模式可節省電費。經過了設定的時間後將開始照常煮水。

請按下 **Re-Boil/Timer** 鍵，
選擇節電的時間。

請看顯示部對照確認。

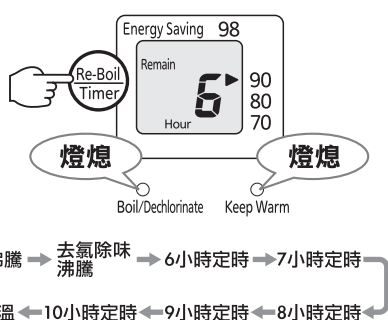

※節電定時結束前的剩餘時間以每1小時顯示。

■如果在設定時間前1小時...

會開始煮沸，以每59~1分顯示。

■煮沸結束時...

會以設定好的溫度保溫。

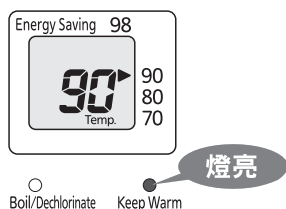

請注意

設定節電定時會無法出水。

解除節電定時進行煮沸時

按 **Re-Boil/Timer** 鍵 讓沸騰 指示燈亮起。
即開始煮沸。

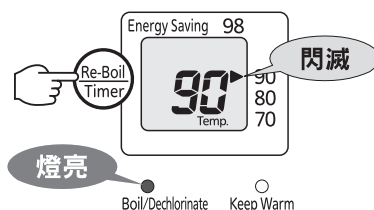

卅

ㄨ

7 使用後

1 拔下插頭。

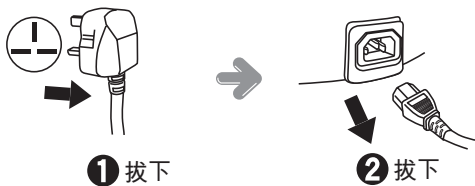

2 拆下上蓋。

一邊按住上蓋裝卸桿 一邊將蓋子朝注水口側拉即可打開拆下。

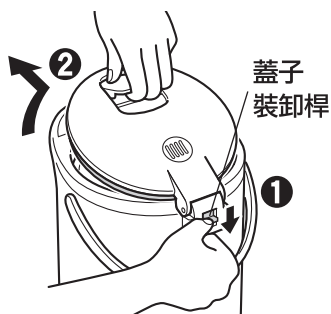

3 倒掉殘餘熱水。(參照 P. 22)

請注意

- 為了避免熱水飛濺，倒掉熱水時請盡量靠近水槽慢慢倒掉。
- 倒掉熱水後，有可能會從注水口滴出殘水，請小心。
- 使用後請經常清洗內容器及小濾網。(請參照 P. 30)
- 倒水時請務必拆除上蓋，以免熱水濺到手上而燙傷或造成故障。

4 安裝上蓋。

一邊按住上蓋裝卸桿 一邊將蓋子掛勾處插入。

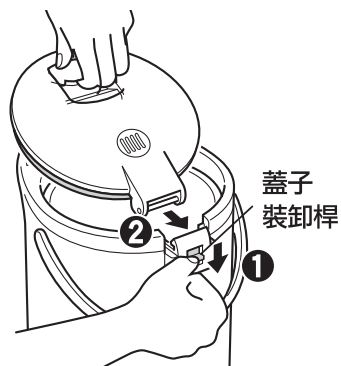



請注意

- 不使用時，剩餘開水不要保留，否則會造成內容器變色或產生味道。
- 小濾球的安裝如不確實，在倒掉殘餘熱水時有時會鬆脫掉落，要小心。

8 保養方法

有關其他維修、售後服務、請務必委託本公司指定的保修人員。

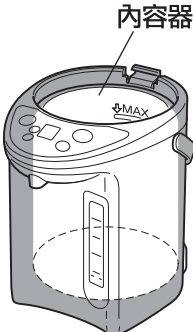
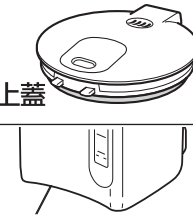
- ◆ 拔掉插頭，倒掉殘留的熱水，讓本產品充分冷卻之後，依照以下說明清潔各部分。
- ◆ 使用較柔軟的海棉、布等。

| 各部位 | 保養方法 |
|--|--|
|  <p>內容器</p> | <p>① 拆下小濾球用海棉清洗。</p> <p>【請注意】</p> <ul style="list-style-type: none"> ● 清潔保養時，請勿使用鹼性的清潔劑清洗。請使用柔軟的布及溫和的清潔劑清潔。 ● 去污粉或刷子類請勿使用，否則氟素加工面會受損，使污垢不易去除。 ● 即使經過氟素加工，如果長時間不做保養，污垢、水垢會黏住而不易清除，煮水時聲音也會變大，請仔細地保養。 ● 因空燒而形成的變色無法去除。 ● 使用礦泉水或鹼離子水（含有非常多的礦物質成分）時，請更加頻繁地清潔內容器。沈積在內表面的礦物質水垢愈多時，容易堵塞本產品內的熱水及蒸氣出口，因而導致功能異常，故請更加頻繁使用檸檬酸仔細清潔。 ● 請勿用力刷洗或用刀子去除附著在內容器的水垢、礦物成分。 <p>② 海綿也無法清除的污垢、水垢，請用檸檬酸（另售）清洗（2~3個月1次）。（參照 P. 31）</p> <p>■ 有關內容器色斑、變色、水中有白色浮游物</p> <p>內容器產生的如生鏽的紅斑點、乳白色、黑色、彩虹般的變色、白色浮游物是因為水中所含的礦物成份(鈣、鎂、鐵等)作用下而生成的。並非內容器本身變色或腐蝕、氟素樹脂剝落。衛生上全無問題，若污垢明顯時，請使用檸檬酸進行清除。</p> |
|  <p>上蓋</p> <p>本產品外側</p> | <p>用充份擰乾的抹布擦去污垢。</p> |
|  <p>電源線</p> | <p>用乾布擦拭。</p> |
|  <p>小濾球</p> | <p>請從內容器取下用小刷子仔細清洗。</p> <p>【請注意】</p> <ul style="list-style-type: none"> ● 仔細洗淨，一旦堵塞，熱水將不易流出。 ● 清洗後一定要確實裝回內容器。 ● 如未安裝小濾球，大型異物可能會掉落幫浦中，造成出水困難。（水垢仍無法阻絕，需定期清潔） |

【請注意】

- 本產品請勿泡在水裡或沖水，恐造成短路、觸電。
- 請絕對不要整體清洗，如果本產品內部進水會造成故障。
- 請勿使用洗潔劑、稀釋劑、去污粉、漂白劑、金屬刷、尼龍刷、化學抹布等。
- 請勿使用碗盤清洗機或烘乾機，以免造成變形。



8 保養方法

使用檸檬酸清洗的方法

請注意 在進行內容器的檸檬酸清洗時一定要遵守以下內容，否則在起泡泡時，熱水飛濺恐遭燙傷。

- 勿加熱水，一定要以生水進行清洗。
- 勿超過滿水位。
- 清洗中請勿打開上蓋。
- 清洗中會沸騰小心蒸氣。

※進行檸檬酸清洗時，無法使用其他操作及功能。

檸檬酸請向虎牌產品銷售店詢問

指定編號：PKS-0120「電熱水瓶內容器洗淨專用檸檬酸（約30g x 4包入）」，洽購。

※檸檬酸清潔劑為食品添加物，食品衛生上為無害。

■ <90分鐘檸檬酸清洗（快速清洗功能）> 適用軟水（每2-3個月一次）

- 1 確認內容器裡的小濾球裝在上面。
- 2 將冷水注入內容器，直至達到滿水位刻度位置。
- 3 將1袋的PKS-0120（30g/2-3匙）檸檬酸粉加入到內容器中，並稍微攪拌。
- 4 插上插頭，同時連續按壓……
[Re-Boil/Timer] 鍵與 [Temp.Set] 鍵約3秒。

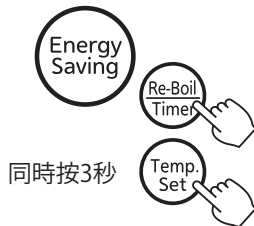

開始清洗。清洗中沸騰指示燈與保溫指示燈交替閃滅，液晶顯示會如下圖移動予以通知。然後切換到清洗剩餘時間的標示。

（洗淨時間約1小時30分*）*依水溫有所差異。

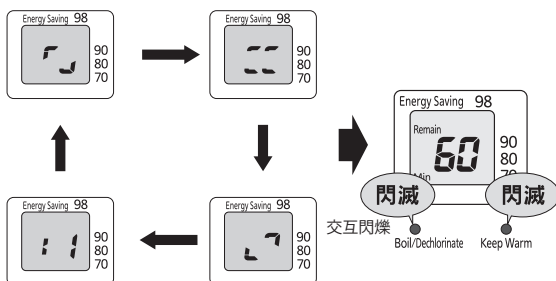

- 5 清洗完成時沸騰指示燈及保溫指示燈變成熄燈狀態，液晶顯示會變成如下圖：

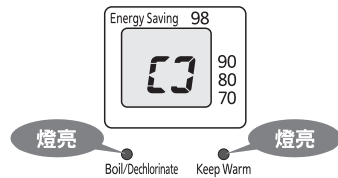

- 6 使用電動式供水將所有熱水（檸檬酸液）從注水口出水後丟棄。
- 7 拔下插頭，倒掉熱水。如果還有污垢，則用海棉擦掉，再用水充份洗淨。
※污垢不易去除時，水沖洗後，請再放入檸檬酸與水進行同樣操作。
- 8 為除去檸檬酸的味道，可以只用水再一次煮沸後倒掉熱水。

請注意 使用檸檬酸清洗途中如欲解除，請拔掉插頭。要跟平時使用一樣煮沸的話，一定要把原來的液體（檸檬酸的液體）倒乾並沖洗乾淨之後才可使用。

■ <利用98保溫設置進行8小時的檸檬酸清洗> 適用硬水

勿使用快速清洗功能（每15-30個日一次）

- 1 確認內容器裡的小濾球裝在上面。
- 2 將冷水注入內容器，直至達到滿水容量標記。
- 3 將1袋的PKS-0120（30g/2-3匙）檸檬酸粉加入到內容器中，並稍微攪拌。
- 4 合上蓋子，並插上電源；選擇98保溫設置。
- 5 靜置至少8小時或整夜。
- 6 按 [Dispense] 鍵，將1/3的水從注水口排出。
- 7 將電源完全拔除，打開頂蓋搖晃剩餘熱水。（參見 P. 22 的插圖瞭解熱水倒出位置）
注：在倒除熱水時請務必小心，否則可能造成燙傷。
- 8 洗淨內容器，然後利用軟海綿/布/紙巾擦淨殘餘物。由於內容器較熱，在擦拭時請小心，可先令其稍微冷卻。
注：如果仍有礦物質堵塞的情況，請重複該步驟。
- 9 要除去檸檬酸的味道，僅可使用清水照常煮沸，通過注水口排出大約一半的熱水，然後再倒掉剩餘的熱水。

長時間不用時

- 1 按 P. 30 要領保養各部位再用乾布擦拭。
- 2 讓各部位自然風乾。（特別是內容器要充份乾燥）
- 3 用塑膠袋等密封保存。

請注意 保存時，請用塑膠袋等密封，避免蟑螂等爬入。

9 懷疑是故障時

在送修前請確認。

| 這樣的情形時 | 看這裡 | 請這樣處理 | 參照頁次 |
|-----------------------------|---|--|-------|
| 不能煮水 (所有的燈及顯示部皆消失。) | 插頭有無脫落。 | 請插上插頭。 | 24 |
| 加入水後，沒有開始煮水。 (沒有切換到沸騰燈。) | 是否放入約 50°C 以上的熱水。 | 請放入稍涼的熱水或生水。 | 24 |
| | | 請按 Re-Boil/Timer 鍵，使其沸騰。 | 25 |
| 熱水自然流出 | 是否水位超過「滿水位刻度」。 | 請降到「滿水位刻度」以下。 | 24 |
| 煮水中出現「咕嘟」聲 | 煮水中所產生的水泡迸裂的聲音，不是故障。 | | 23 |
| | 是否選擇節能功能。在節能保溫中若有操作面板，將自動恢復到原先所設定的預設溫度。聲音為此時所產生的氣泡聲。 | | 27 |
| 煮水聲音比平時大 | 內容器是否髒了。 | 使用檸檬酸洗淨功能清洗內容器及本產品內部的出水管。 | 31 |
| 不會沸騰。 (沒有出現蒸氣) | 是否選擇節能功能。為了減少蒸氣，利用節能煮水的情形之下，機器會在約 98°C 時結束煮水。 | 使用「去氯除味」功能煮水。 | 24・25 |
| | 是否按了再沸騰。再沸騰會將已經煮沸過一次的熱水再次煮沸，機器有設定減少蒸氣。 | | — |
| 開水有味道 | 因自來水中所含消毒用的氯使用量不同而會殘留消毒水味。 | 使用「去氯除味」功能煮水。 | 24・25 |
| | 是否選擇節能功能。為了減少蒸氣，利用節能煮水的情形之下，機器會在約 98°C 時結束煮水。 | | |
| | 剛開始使用時，有時會有樹脂等味道，隨著使用時間久後會變少。 是否在塑膠片等墊子上使用。墊子的味道有時會傳到熱水裡去。 | | — |
| 本產品外側發熱 | 室溫高的房間持續保溫下，本產品外側有時會發熱，並不是異常。 | | — |
| 內容器髒污 熱水中有白色浮游物 | 那是在水中所含礦物質成份作用下而產生的，並非內容器本身的變色或腐蝕、氟素樹脂剝落。 | 使用檸檬酸洗淨。 | 31 |
| 熱水是溫的 | 是否選擇節能功能。利用節能保溫時，預定溫度會降約 5°C 維持保溫。 | 按住 Temp.Set 鍵或 Unlock 鍵約 1 分鐘，即可恢復至預設溫度。 | 27 |
| | 因第 1 杯熱水積存在水量顯示計的水量管中，熱水流會是溫水。 | | — |
| 電動出水，無法出水時。 | 本產品是否在傾斜狀態下給水。 | 請將本產品扶正。 | — |
| | 插頭有無脫落。 | 請插上插頭。 | 24 |
| | 是否在自動鎖住的狀態。 | 請按 1 次 Unlock 鍵後即可給水。 | 25 |
| | 沸騰後是否立刻取水。 | 請小心蒸氣打開一下上蓋。 | |

冊

✕

9 懷疑是故障時

| 這樣的情形時 | 看這裡 | 請這樣處理 | 參照頁次 |
|-------------|----------------------------|---|------|
| 電動出水，無法出水時。 | 內容器小濾球或內部幫浦是否髒污。 | 使用檸檬酸清潔洗淨。 | 31 |
| 顯示部份有霧氣。 | 是否置放在容易沾到水或是底部容易沾濕的地方。 | 請將水倒掉，並以沒有通電的狀態下讓霧氣散去。 霧氣無法消除時，請送至虎牌購買處維修。 | — |
| | 本產品是否倒置。 給水時，操作面板是否沾到水。 | | |

有下列情形時

| 這樣的情形時 | 看這裡 | 請這樣處理 | 參照頁次 |
|-----------------------------------|---|---|------|
| 防止空燒功能運作時，沸騰指示燈和保溫指示燈會交互閃爍。如下圖表示。 | <p>是否在空燒或水量太少。</p> <p>是否熱水已用完，卻仍長時間任其靜置，或為了加水而任由上蓋開著。</p> <p>加水時是否加得太快。</p> | <p>拔下插頭，加水直到給水記號以上，過一會再插入插頭。</p> <p>拔下插頭，稍待一會再插回。</p> | 24 |
| 沸騰指示燈和保溫指示燈交互閃爍。如右圖。 | — | 可能在給水或清潔時本體內部因進水而產生故障。 請洽經銷商進行修理。 | — |

規格

| | | 3.0L型 | 4.0L型 |
|-----------------------|------|-------------------------|--------|
| 額定容量 | | 3.0L | 4.0L |
| 電源 | | AC 220 - 230V (50/60Hz) | |
| 消費電力 | 煮沸電力 | 682W-745W | |
| | 保溫電力 | 65-71W | |
| 外形尺寸(約) (將把手傾倒的狀態) | 寬 | 21.2cm | |
| | 深 | 28.0cm | |
| | 高 | 29.4cm | 34.4cm |
| 重量(約)(含電源線) | | 2.3kg | 2.5kg |

※ 特定地區(高山、嚴寒地區等)有時會無法確保原有性能。

關於消耗品·耗材洽購

請至全省虎牌直營門市洽購

上蓋墊圈 (消耗品)

請以1年為基準做確認，若出現以下情形請更換。
(翻倒時熱水漏出，有燙傷的危險)

- 變白。(裂化前現象)
- 污損明顯。
- 從上蓋的縫隙中會散出蒸氣。

| | |
|------|---------|
| 零件型號 | PDA1090 |
|------|---------|

樹脂零件 (消耗品)

會接觸到熱及蒸氣的樹脂零件，會隨使用情況而受損，請更換零件。(另洽購)

小濾網 (消耗零件)

即使加入檸檬酸清潔劑與內容器同時清洗污垢仍然無法洗淨時，請更換零件。

| | |
|------|---------|
| 零件型號 | PVH1184 |
|------|---------|

更換上蓋墊圈的方法

拆卸方式

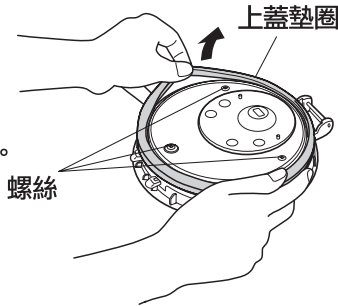
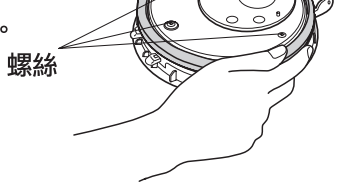
- 1 請鬆開螺絲 (3 根)。

- 2 拆卸上蓋墊圈。

安裝方式

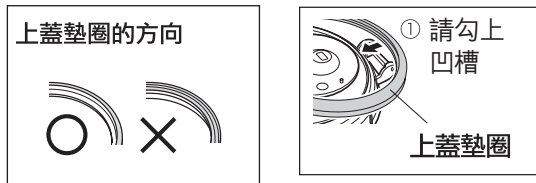
- 1 將新的上蓋墊圈確實嵌入在栓內蓋外圍。

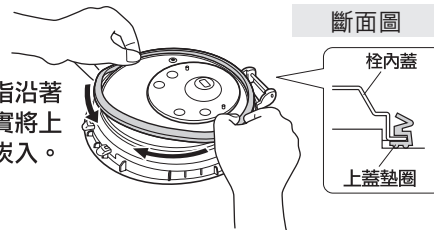

- 2 請用手指沿著凹槽確實將上蓋墊圈嵌入。

請確認是否有確實嵌入。

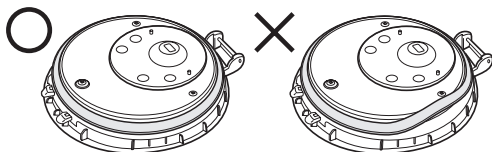

- 2 請確實將螺絲(3 根)控緊。

請注意

- ◆ 栓內蓋等零件，請勿從上蓋拆卸。避免蒸氣溢出或造成出水有問題。若墊圈脫落，請依照下圖正確安裝。

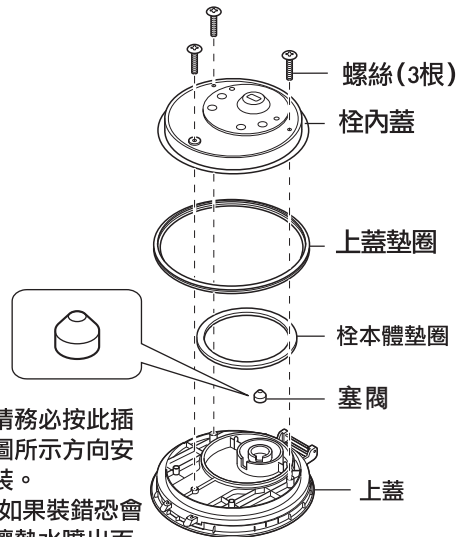

欲拆解或更換上蓋零件時，必須由製造廠或其服務處或具有類似資格的人員更換。以避免熱水自然流出造成燙傷，或產品損壞。具體詳情請至原購買處洽詢。

冊
✕

1 安全注意事项

使用前请仔细阅读，并务必遵守。

※ 此处标识的注意事项是为防止对使用者及他人造成危害及财产损失。此注意事项为安全相关的重要内容，请务必遵守。

※ 请勿撕下贴在本体上的注意事项贴纸。

因忽视标识的内容，操作错误产生的危害及损害程度，按以下表示来区分说明。



警告

表示如果用户操作不当，可能会造成使用者伤害或物品损坏^{*1}的内容。



注意

表示如果用户操作不当，可能会造成使用者伤害^{*2}或物品损坏^{*3}的内容。

*1 重伤是指因失明、受伤、烫伤（高温·低温）、触电、骨折、中毒等留下的后遗症及需要住院治疗或长期看门诊的。

*2 伤害是指无需住院治疗的受伤、烫伤或触电等。

*3 物品损坏是指损害扩大到房屋，家产及家畜、宠物等。

图标记号的说明



注意

△ 记号表示禁止的行为。具体的禁止内容用图或文章标注在图标记号的中间或附近。



禁止

⊘ 记号表示禁止的行为。具体的禁止内容用图或文章标注在图标记号的中间或附近。



指示

● 记号表示强制行为或指示的内容。具体的指示内容用图或文章标注在图标记号的中间或附近。

有婴幼儿的家庭，需特别注意勿让婴幼儿触碰到。



警告



请勿让儿童独自使用，或在婴幼儿可以触碰到的地方使用。
以免造成烫伤、触电或受伤。



请勿让婴幼儿舔吮产品插头。
注意勿让婴幼儿误舔，以免造成触电或受伤。

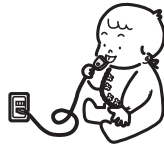

请勿让身体行动不便或没有充分理解使用方法的人单独使用本产品。
如需使用时务必要有充分理解使用方法的人在旁指导确认。
以免造成烫伤、触电或受伤。



关闭上盖直到听见「咔」的声音。
以免引发沸腾不止或倾倒时开水流出，造成烫伤。



禁止接触

请勿将脸部触碰或靠近蒸汽孔。
以免烫伤。特别要注意不要让婴幼儿触碰。



注意



请勿在不稳定的场所，耐热性差的桌子及毛毯等上面使用。
以免因倒下时热水的流出导致烫伤。
以免引发火灾或使台面、垫子变色变形。

警告



禁止分解

请勿改装。
除维修技术人员以外,不可拆卸修理。
以免造成火灾、触电、受伤。



不可使用额定电压以外的电源。
以免造成火灾、触电。



请单独使用额定电流7A 以上的插座。
以免因与其它电器同时使用,造成多头插座异常发热或起火。



请勿使用已破损的电源线及损坏电源线
(如加工·强行弯曲·接近高温部·拉扯·扭曲·捆扎·压在重物下、夹在物中等行为。)
以免造成火灾、触电。



如果电源插头上有灰尘,请及时擦拭干净。
以免造成火灾。



请将电源插头完全插到底。
以免造成触电、短路、起火。



电源线或电源插头破损或插座松动时,
请勿使用。
以免造成触电、短路、起火。



如果电源软线损坏,必须用专用软线或
从其制造商或维修部买到的专用组件来
更换。



禁止湿手

请勿用湿手插入或拔出电源插头。
以免造成触电或受伤。



加水请勿超过满水刻度线。
以免造成开水溢出,烫伤。
此外,如果内容器里的水量少于加水刻度线时,
有可能会造成内容器的变色、故障。



请勿猛力关闭上盖。
以免开水溢出而烫伤。



请勿将抹布覆盖在蒸气孔上。
以免开水溢出而烫伤。另外,也会造成上盖的变形。



禁止烧煮水以外的饮品。
如放入茶、牛奶、酒、袋泡茶或茶叶、速食食品等
时,有可能会因起泡溢出而造成烫伤。
另外,也会造成结块、腐蚀、故障、氟素加工面脱落。



请勿放入冰块用于保冷。
以免放入冰水或冰块会使外部凝结出小水珠,
造成触电、故障。



沸腾中,请勿打开上盖。

1 安全注意事项

警告



请勿将本体抱在怀中、使其倾斜、摇晃、或上下用力摇、加以撞击。不可只抓住上盖移动本产品。

即使在上锁的情况下也不可倾倒。
以免开水溢出造成烫伤。



请勿将电热水瓶倾倒。
即使在上锁的情况下也不可倾倒。
以免开水溢出造成烫伤。



请勿将本产品放入水中或向其泼水。
以免造成短路、触电、起火。

禁止弄湿



禁止在上盖装在本体的状态下，倒除剩余的开水。

拆下上盖时，请注意剩余的开水，
以免烫伤。
(倒除剩余开水的方法 → p. 38,45)



上盖垫圈发白请更换。
以免翻倒时开水流出，引发烫伤。



发生异常或故障时，立即停止使用。
若继续使用，可能会造成火灾、触电及受伤。
<异常·故障事例>

- 使用中，电源线或电源插头异常发热。
- 触动电源线会有通电不稳定的现象。
- 与以往不同变得异常热或有烧焦的味道。
- 本体有漏水。
- 有其它异常或故障。

请立即拔下电源插头，联系使用说明书上记载的服务热线。

注意



插头拔出

不使用时，请从电源插座上拔下插头。
以免因损伤、绝缘体老化而造成触电、漏电、火灾。



拔电源插头时请务必手持插头部分拔下。
以免因触电或短路造成起火。



请使用本产品专用的电源线。禁止与其它电器共用电源线。
以免造成故障、着火。



请勿使用分路插座。
以免造成火灾。



请勿放置在容易淋到水或沾湿产品底部的地方使用该产品。
以免造成触电、短路、引起故障。



请勿直接从水龙头接水。
以免本体内部进水，造成触电、短路、故障。



请勿使插头暴露于蒸汽环境，以免造成触电或火灾。

在滑动的桌面上使用本产品时，注意不要使蒸汽喷到产品上。

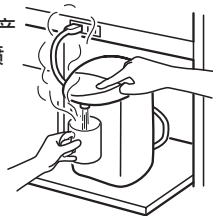

禁止在靠近墙壁和家具的地方使用。
蒸汽和热量会导致墙壁、家具的变色、变形。放入厨房墙壁柜时，应保持良好的通风。

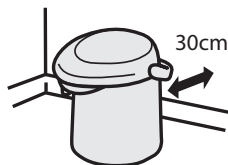

⚠ 注意



禁止接触

请勿在打开或拆下上盖时,触碰到冒出的蒸汽。

以免烫伤。



请勿在水沸腾时,按出水键。

以免开水溅出,引起烫伤。



请勿在倒水时摇晃本体。

以免开水溅出,引起烫伤。



禁止接触

请勿在使用中或刚使用完,触碰高温部位。

以免烫伤。



请勿在搬运产品时,触碰上盖开关片。

以免因上盖打开而受伤或烫伤。



请待产品冷却后再进行清洗。

以免因触碰到高温部位而烫伤。



清洁保养前,请务必将电源插头从插座拔下,从本体的电源插口上拔下产品插头。

清洁保养完后,再次使用时请确认电源线两端的插头及本体上的电源插口是否充分干燥后再插入使用。

插入电源时请勿移动本产品。

以免造成短路、触电、起火。



请勿整体清洗或让水浸入产品的内部或底部中。

以免触电、短路、引起故障。



为了避免蒸气外漏,请确实关紧上盖。



倒除残留开水时,请务必按照下图方向操作。

以免从别的位置倒水,导致产品内部进水而引发故障。并有可能造成烫伤。

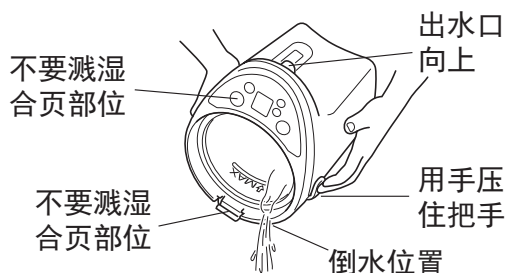

禁止将热水瓶倒置。

以免引起故障。



该产品在家庭内或在以下场所都可以使用,但需要注意。

- 商店,办公室等的茶水间
- 农场
- 在酒店等住宿的客房
- 在民宿等简易住宿的客房

为了延长使用寿命,请遵守以下事项。

- 请勿在靠近烟火处使用。以免造成产品变形故障。
- 请勿放置在长时间阳光直射的地方使用。以免因本体发热而引起故障。
- 禁止空烧。在容器内没有水的情况下通电,会因受热而引起内容器变色、故障。
- 请勿放入活性炭等物。以免引起故障或使氟素加工面脱落。
- 拔下电器电源插头,如果将产品长时间存放在一个会结冰的环境时,请确保内部容器里没有一点水。

2 各部件名称和附件

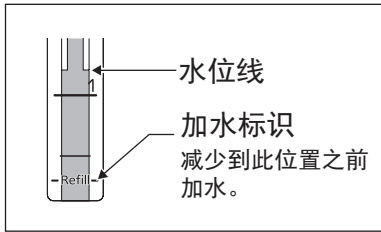
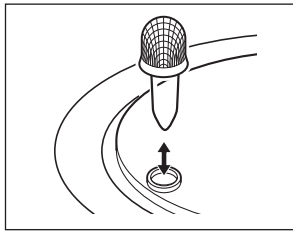
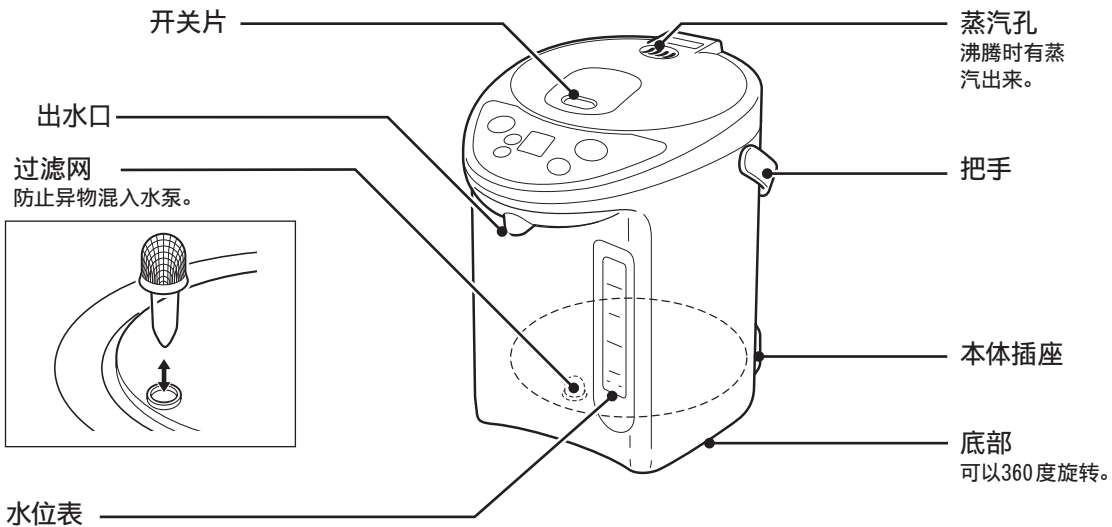

注意 旋转本体时，请注意不要让本体插头掉落。

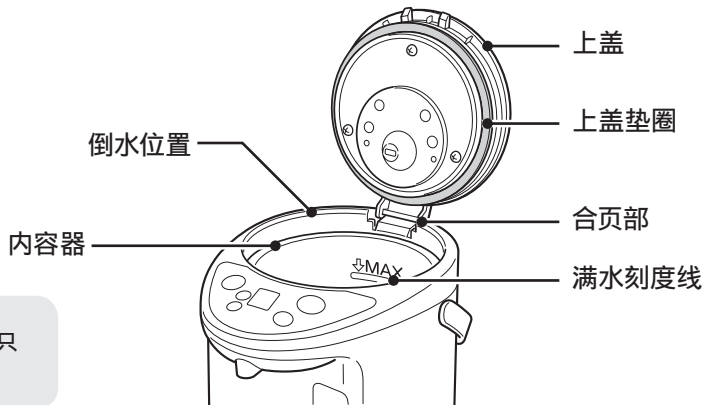

本说明书中列出的 98、90、80、70 等数字只是大概温度。

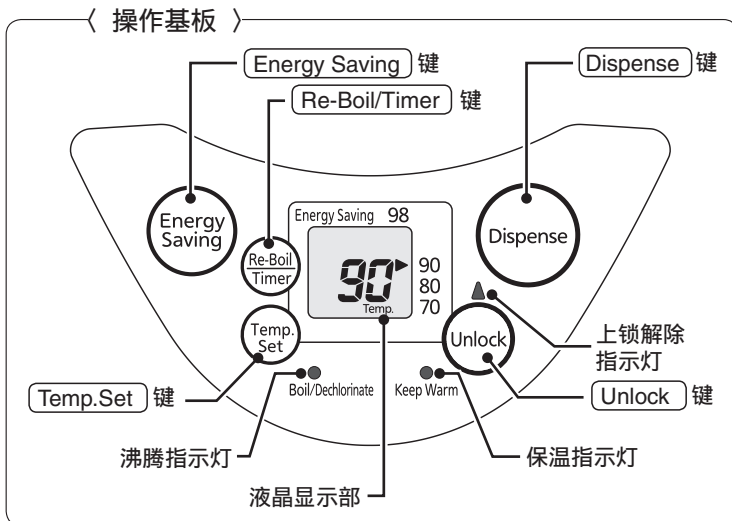

〈 电源线 〉



声音

水烧开时，会听到容器内有鼓泡声。这是正常现象，并不表示故障。

3 烧水

初次使用时/好久没有使用时

清洗本体内部，按照以下顺序，将水烧开后倒除。
初次使用时会有树脂等的气味，但是会随着使用减少。

1. 水加至满水刻度并煮沸。
2. 等水烧开后，用电动出水方式倒掉约一半的水。(→ p. 42)
3. 拔掉电源插头，打开上盖后，将残留的水分倒除。(→ p. 45)

1 打开上盖。



(((声音)))

「哗啦哗啦」的声音是防止开水流出的安全阀(中栓阀)发出的声音。

2 用其它容器加水。

水加至「满水刻度」和「加水标识」之间。

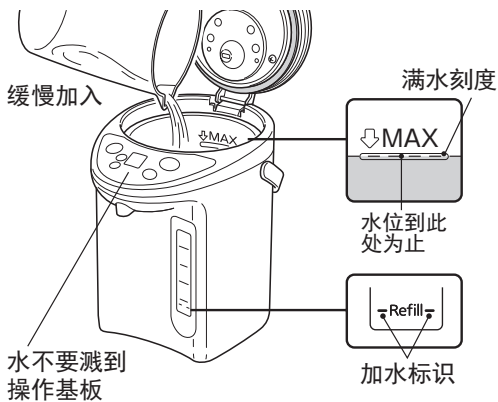

注意

- 请勿从水龙头直接接水或放在潮湿的地方把底面弄湿。
- 如果加入50度以上的水，可能会导致无法自动烧开。加入低温的水使其再沸腾。(→ p. 41)
- 禁止加水量超过「满水刻度」或烧煮水量少于「加水标识」的水。

3 关掉上盖，确实插入插头。

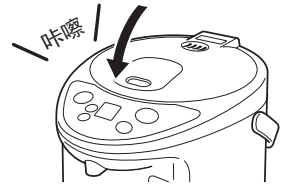

注意

如果壶盖没有盖紧，则在它倒下时开水可能会溢出，造成烫伤。

4 连接电源线。

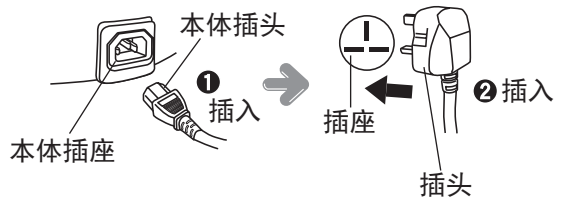

5 开始烧水。

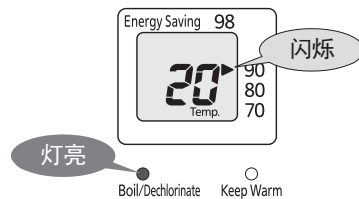

- ※ 选择温热装置温度时请参阅 p. 41。(如果未做任何选择，则将会自动将温度设为 90度。)
- ※ 请参阅 p. 44 了解如何设置节能定时。

■ 想去除氯味时

- 按1次 **Re-Boil/Timer**。
- ※ 烧水的时间比通常要长。

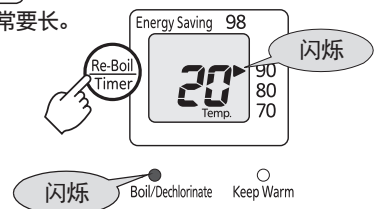

3 烧水

6 选择保温。

按1次 **Temp.Set** 。

■选择90·80·70·98保温时

每按一次 **Temp.Set** 保温温度会依次替换。

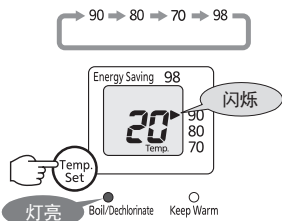

无论在烧沸时还是保温时，都可以调整保温温度。

注意 使用过程中电源线脱落时再次插上电源时自动跳到90度保温。

■煮沸期间

当前水温

煮沸前的剩余时间

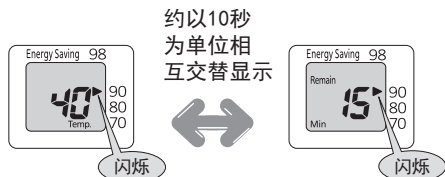

约以10秒为单位相互交替显示

※ 根据水量和水温，开始显示剩余时间的具体时间会不同。
 ※ 水温按照每5度显示。(如果大约为98度，则会显示“98”。)

7 自动保温。

■沸腾后

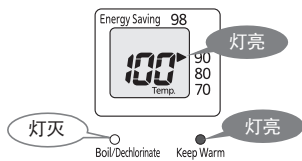

■达到所选温度时

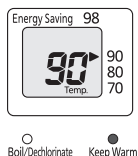

注意

- 请勿接触到蒸汽以免被烫伤。
- 打开或关闭盖子时请勿过分用力，在煮沸期间或刚煮沸时不要出开水，以免开水溢出或蒸汽喷出而造成烫伤。

沸腾时间,到所选保温温度的大致时间

| | 3.0L 型 | 4.0L 型 |
|-------------|-------------|-------------|
| 加水到沸腾 | 约 30 分 | 约 40 分 |
| 到 90 度温度的时候 | 约 55 分 | 约 1 时间 5 分 |
| 到 80 度温度的时候 | 约 1 时间 45 分 | 约 1 时间 55 分 |
| 到 70 度温度的时候 | 约 3 时间 5 分 | 约 3 时间 25 分 |

※ 水量：满水、水温、室温：23℃时的参考值。
 ※ 到98℃保温为止的大致时间与到沸腾为止的时间大致相同。

保温过程中要再沸腾时,按一次 Re-Boil/Timer 。

先确认热水量是否在加水标识以上。

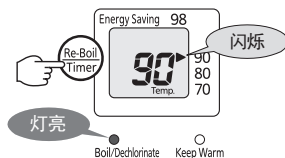

满水时到再沸腾为止的大致时间

| | 3.0L 型 | 4.0L 型 |
|------------|-------------|-------------|
| 98 / 90 保温 | 约 5 ~ 10 分 | 约 5 ~ 11 分 |
| 80 保温 | 约 10 ~ 12 分 | 约 12 ~ 14 分 |
| 70 保温 | 约 14 ~ 16 分 | 约 17 ~ 19 分 |

※ 加水或重新插电时间都会变长。

■想去氯除味时

按2次 **Re-Boil/Timer** 。

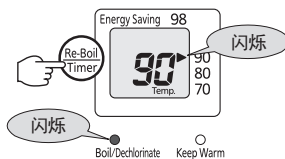

每按1次 **Re-Boil/Timer** 功能会相互替换。

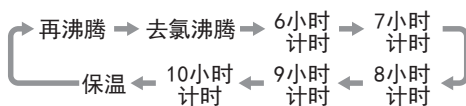

※ **Re-Boil/Timer** 与省电定时属于共用按键，因此请在液晶显示部确认后设置。

4 按出水键倒出开水

1 按一次 **Unlock** 。



2 将容器对准出水口, 按 **Dispense** 倒水。

按住期间, 出水。

- ※ 松开 **Dispense** 把手拿开, 待确认出水口停止出水后, 拿开容器。
- ※ 如果按下设备的电源插头, 则不能出热水。
- ※ 刚沸腾后, 产生的气泡进入本体内部的水泵中会导致出水不顺畅。注意蒸汽, 把上盖打开, 再关上上盖后出水。
- ※ 内容器或过滤网, 内容器的水泵有脏污时也会导致出水不顺畅。柠檬酸清洗。→ p. 47
- ※ 出水后, 约10秒钟没有按 **Dispense**, 将会自动上锁。(上锁解除指示灯熄灭。)



- 注意**
- 开水量少于加水标识时, 不要出水。以免造成开水飞溅。
 - 出水时请勿让本体转动, 以免开水洒落, 造成烫伤。

3 按一次 **Unlock** 。

会被上锁。



■ 当热水变少务必要加水

在水量减少到加水标识前, 务必加水, 关上上盖。(加水时注意蒸汽。) → p. 40

注意

请务必让设备里存有一些水, 以免干烧造成故障。

5 设定节能功能

选择节能功能，会进行节能烧水和节能保温。

- 节能烧水是，在水沸腾之前停止加热，并控制蒸汽量。烧水结束时的水温约为98度。（根据室温、水量、气压的不同可能会有无法切断蒸汽的状况。）
- 节能保温是指，2小时以上没有进行按键操作时，以低于设定温度5度的水温保温的功能。设定98度保温时的节能保温为93度。）

1 选择 [节能功能]

按住 [Energy Saving] 键一秒。

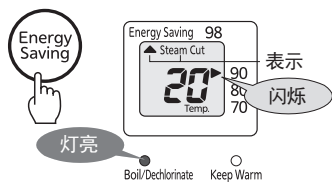

■节能功能下不想切断蒸汽时(使其沸腾)

用「除氯」烧水。→ p. 40

2 选择保温

→ p. 41

3 一旦水达到沸点，它会自动切换到保温模式。

■煮沸周期完成

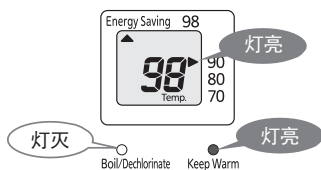

■水达到设定温度

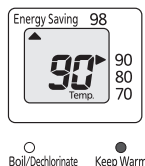

■如果设备 2 小时没使用，它会自动切换到节能模式。

(低于正常设定温度 5 度)

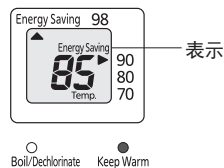

想在节能保温下，返回到原来设定的温度时

按1次 [Temp.Set] 或 [Unlock] 。

解除节能功能时

长按 [Energy Saving] 键。(水温低时，开始自动烧水。)

注意

即使在节能烧水时，蒸汽孔也处于高温，请勿触碰，或让脸部靠近。

6 设定省电计时

节能定时可以设为 6 到 10 小时 (间隔为 1 小时)。您可以在睡觉或外出前设定它；设备在节能期间会切断电源。定时结束时，设备会自动对水重新加热。

按 **Re-Boil/Timer** 选择省电计时。

看着显示屏进行调整。

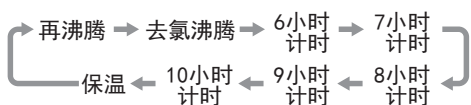
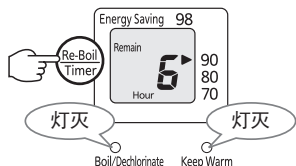

※ 以1小时为单位显示到省电计时结束为止的时间。

■ 到省电计时结束剩1小时时。

开始烧水，并从59 ~ 1分以分钟为单位显示。

■ 烧水结束后自动保温。

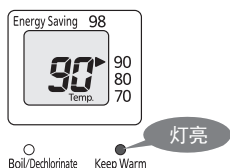

注意 开启节能定时时，电动出水装置不工作。

解除省电计时烧水时。

按 **Re-Boil/Timer**，让沸腾指示灯亮起。(开始烧水)

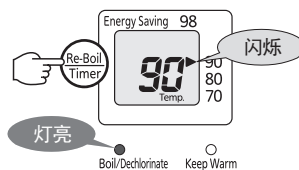

7 不使用时倒除开水

1 拔下插头。

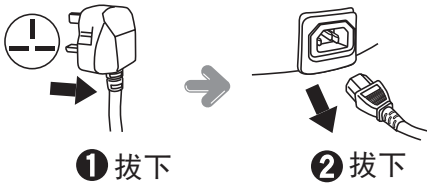

2 拆下上盖。

一边按住上盖合页开关片，一边把上盖向出水口的方向拉出。

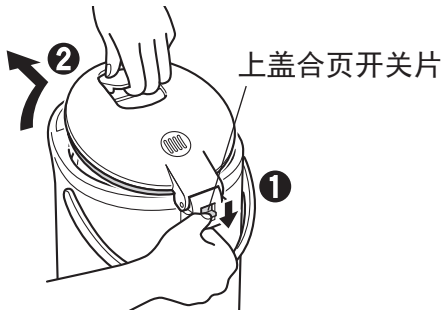

3 倒除残留的热水。→ p. 38

注意

- 为防止开水飞溅，请尽量靠近水池，并缓慢倒出。
- 倒除完热水后，出水口会有水滴滴落，请多加注意。
- 使用后请清洗，内容器，过滤网要仔细清洗。→ p. 46

4 安装上盖。

一边按住上盖合页开关片，一边把上盖向里插入安装上。

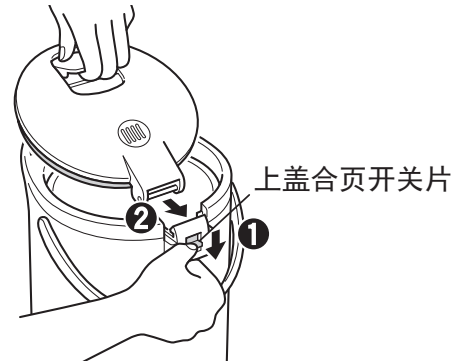

注意





- 内容器中不要残留热水，可能会导致内容器变色，有异味，所以残留热水要倒除。
- 不要在安装上盖的状态下，倒除残留热水。
- 过滤网安装不严时，可能会随着倒除的热水掉落，请多加注意。

8 进行清洗

所有其它维修保养工作均应交由授权服务人员

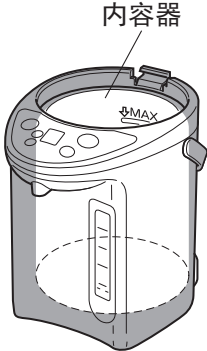
■ 拔掉插头,待冷却后清洗。

■ 选用柔软的海绵、抹布。

| 部件 | 清洁 |
|---|--|
|  <p>内容器</p> | <p>① 只需用水彻底冲洗,然后用干净的海绵或纸巾擦拭内壁即可。</p> <div style="border: 1px solid black; padding: 5px;"> <p>注意</p> <ul style="list-style-type: none"> • 为防止对电热水瓶造成损坏,清洁时请勿使用碱性清洁剂,请使用软布和柔和的清洁剂。 • 请勿使用用于顽固污渍或水垢的洗洁或擦洗用具等材料,以免对不粘(氟聚合物)涂层表面造成损坏。 • 所有含矿物质的水在煮沸后都会在内壁留下水垢。如果长时间不清除,煮水时可能会听到很大的噪音。建议经常进行清除。 • 如果不清除,水垢最终会将水管和或蒸汽孔堵塞。如果持续按“出水”键,则这种堵塞会造成电动机烧掉。 • 请勿刮擦或使用刀具清除水垢。 • 干烧造成的变色是无法清除的。 </div> <p>② 要清除水垢,请每 2-3 个月使用一次柠檬酸清洁剂。(→ p. 47)</p> <div style="border: 1px solid black; padding: 5px;"> <p>■ 容器内部颜色不均匀或变色,水中飘浮白沫</p> <p>容器内部出现的铁锈般红斑、牛奶白变色、黑斑、彩虹色和飘浮白沫是由水中的矿物质(钙、镁、铁等)相互作用造成的。这不是容器内部本身氟聚合物涂层表面的变色、铁锈或脱落。尽管不会有卫生/健康问题,但建议在热水器开始出现这类污渍时经常做一下清洁。</p> </div> |
|  <p>上盖</p> | |
|  <p>本体外侧</p> | <p>用湿布或纸巾将污渍擦除。</p> |
|  <p>电源线</p> | <p>用干布擦除。</p> |
|  <p>过滤网</p> | <p>从容器内部取出过滤网。用牙刷等软毛刷清洗一下。</p> <div style="border: 1px solid black; padding: 5px;"> <p>注意</p> <ul style="list-style-type: none"> • 建议经常清洗,这可以避免堵塞,进而造成出热水不畅。 • 清洗后,务必将过滤网牢牢装回容器内部。 • 没有安装的话,异物进入水泵会造成不出水。 </div> |

注意

- 请勿浸于水中或向其泼水。
- 切换对整个设备进行冲洗,以免设备内进入造成故障。
- 请勿使用清洁剂、稀释剂、去污粉、漂白剂、金属球、尼龙刷、化学抹布等物品进行清洗。
- 请勿使用洗碗机或烘碗机。

8 进行清洗

如何用柠檬酸清除水垢

注意

- 用柠檬酸冲洗容器内部时，务必遵照以下指示，以避免开水溢出或烫伤。
- 请勿注入热水。务必用冷水冲洗。
 - 请勿让注水超过最高水位。
 - 请勿在清洗过程中打开盖子。
 - 冲洗过程中要小心热蒸汽。

※ 在冲洗过程中其它功能不能使用。

联系销售电热水瓶的 Tiger 产品零售商并指定产品编号 PKS-0120“用于清洗电热水瓶容器内部的柠檬酸（约 30g x 4 包）”即可购买柠檬酸。

※ 清洗用柠檬酸使用于食品添加剂，所以在食品卫生安全方面是无害的。

■使用“快速功能” > “用于软水”，柠檬酸冲洗时间不超过 90 分钟（2 ~ 3个月进行1次）

- 1 请确认过滤网是否安装在内容器上。
- 2 把水加至满水刻度后拌匀。
- 3 约30g 柠檬酸（1包）放入内容器。
- 4 连接电源同时按3秒钟 **(Re-Boil/Timer)** 和 **(Temp.Set)**。

冲洗将开始。冲洗过程中，保温指示灯和沸腾指示灯将交替闪烁，表示正在进行冲洗，显示屏改变如下。之后它会切换显示剩余冲洗时间。

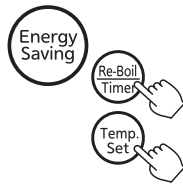

同时按约3秒钟

<清洗的标准时间：约1小时30分 >

※ 根据水温会有所不同。

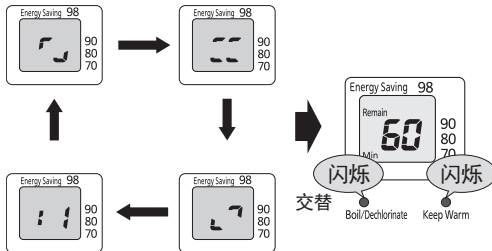

- 5 冲洗完成后，保温指示灯和沸腾指示灯会亮起。显示屏指示如下：

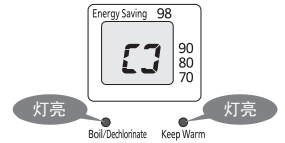

- 6 按 **(Dispense)** 键，通过喷口排出全部的热水。
- 7 拔掉电源线和上盖，将热水倒除。如有脏污粘附时，用海绵擦掉。（不易擦掉时，再度放入柠檬酸和水重复操作。）
- 8 为了充分倒除含有柠檬酸的剩余水分，请使用清水按通常做法烧开，并用电动出水方式倒除约半量的水后，将剩余的水倒除。

注意

要取消柠檬酸清洗时，拔掉电源插头。按通常的方式烧水时，务必把热水（柠檬酸混合液）倒除后使用。

■使用“98 温度设置” > “用于硬水”，柠檬酸冲洗时间不超过 8 小时

请勿使用快速清洗功能。（此指引每 15-30 天一次）

- 1 请确认过滤网是否安装在内容器上。
- 2 把水加至满水刻度后拌匀。
- 3 约30g 柠檬酸（1包）放入内容器。
- 4 合上盖子并插接，然后选择 98 温度设置。
- 5 保持至少 8 小时或整晚。
- 6 按 **(Dispense)** 键，从喷口排出 1/3 的水。
- 7 拨下电热水瓶电源插头，揭开顶盖以摇晃剩余的水。（请参阅 p. 38 图示了解热水排出位置）
注意：在排出热水时要多加小心，以免烧伤或烫伤。
- 8 冲刷一下容器内部，然后用软海绵/布/纸巾将其擦干。擦拭容器内部时要小心，因为它温度很高；让它凉下来。
注意：如果仍有水垢，请重复执行程序。
- 9 要消除柠檬酸味，请像平常一样煮水，通过喷口排出约一半的热水，然后丢弃剩余的水。

长时间不使用时

- 1 按照 p. 46 的说明，清洗每个部件，用干布擦拭。
- 2 使各部位自然干燥。（特别是内容器要充分干燥。）
- 3 请用塑料袋密封保管。

注意

为了防止虫子或灰尘进入，请用塑料袋密封保管。

9 认为发生故障时

在委托修理前，请确认以下内容。

| 问题 | 确认 | 措施 | 参考页 |
|----------------------------|--|--|-------|
| 无法烧水（所有的指示灯和液晶显示都无法连接或不亮。） | 插头是否脱落。 | 请插上插头。 | 40 |
| 加水也不开始烧。（无法切换到沸腾指示灯。） | 是否加入了约 50 度以上的热水。加入了约 50 度以上的热水时，会出现无法自动烧水的情况。 | 加入冷水或温度较低的水。 | 40 |
| | | 按 Re-Boil/Timer ，使其沸腾。 | 41 |
| 开水自动的流出。 | 加入的水是否超过了「满水位刻度线」。 | 加水时请注意不要超过「满水位刻度线」。 | 40 |
| 发出「鸣」的声音。 | 「鸣」的声音是烧水过程中产生的气泡崩开的声音。 | | 39 |
| | 是否选择了节能功能。在节能保温过程中有按键操作时，为了返回设定的温度将会自动烧开。此时产生的气泡发出的声音。 | | 43 |
| 煮水的声音比平时大。 | 内容器有脏污时，声音会变大。 | 进行柠檬酸清洗。 | 47 |
| 不沸腾。（没有蒸汽出来。） | 是否选择了节能功能。由于切断蒸汽进行节能烧水，所以在 98 度时结束烧水。 | 选「除氯」烧水。 | 40•41 |
| | 是否选择了再沸腾。由于再沸腾是在已经沸腾的基础上再一次烧水，所以自动设置为控制蒸汽。 | | - |
| 开水有异味。 | 根据自来水中含有的消毒用漂白粉的量，可能会有氯味残留。 | 选择「除氯」烧水。 | 40•41 |
| | 是否选择了节能功能。由于切断蒸汽进行节能烧水，所以在 98 度时结束烧水。 | | |
| | 开始使用时，可能会有树脂的味道，多使用几次后便会消失。 | | - |
| | 是否放在塑料布或盆上使用。开水中可能会有塑料的味道。 | | - |
| 本体外侧发烫。 | 在室温高的房间持续保温，本体外侧会发烫。 | | - |
| 内容器有脏污。（开水中含有白色悬浮物悬浮。） | 自来水中含有的矿物成分作用，并不是内容器自身的变色或腐蚀或氟树脂的脱落。 | 进行柠檬酸清洗。 | 47 |
| 水是温水。 | 是否选择了节能功能。在节能保温过程中会以小于设定温度 5 度保温。 | 按 Temp.Set 或 Unlock ，约 1 分钟就可以回到设定的温度。 | 43 |
| | 在倒第 1 杯水时，会包含水位管里积存的水，所以会导致倒出的水温度不够。 | | - |
| 电动出水时不出水，不易出水。 | 是否在本体倾斜的状态下出水。 | 将本体水平放置后出水。 | - |
| | 插头是否脱落。 | 请插上插头。 | 40 |
| | 是否上锁。（上锁解除指示灯灯灭） | 按 Unlock ，再按 Dispense 。 | 41 |
| | 是否沸腾刚结束。 | 注意蒸汽，打开 1 次上盖，再关闭上盖出水。 | |

9 认为发生故障时

| 问题 | 确认 | 措施 | 参考页 |
|----------------|-------------------------------|--------------------|-----|
| 电动出水时不出水，不易出水。 | 内容器或过滤网，本体内部的水泵有脏污时，会有不出水的状况。 | 进行柠檬酸清洗。 | 47 |
| 液晶屏幕有雾气。 | 是否放置在易淋到水或浸湿底部的场所。 | 将水倒除，拔掉插头，放置至雾气消失。 | - |
| | 是否有将产品倒置。 | | |
| | 加水时，操作面板上是否有淋到水。 | | |

显示信息

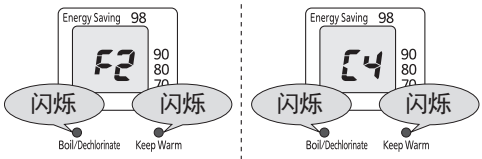
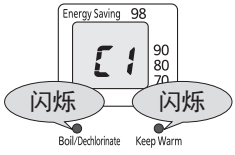
| 问题 | 确认 | 措施 | 参考页 |
|--|---|---|-----|
| 发出「哔哔哔…」的提示音，沸腾和保温指示灯交替闪烁，并有如下显示。  | 是否空烧或烧少量的水。 是否在使用完开水后长时间放置或打开上盖的状态下放置。 | 拔下插头，加水至水量超过加水标识，关闭上盖，稍等片刻后插上插头。 | 40 |
| | 是否在出水时，用力过度。 | 拔下插头，稍等片刻后插上插头。 | |
| 沸腾和保温指示灯交替闪烁，并有如下显示。  | - | 加水或清洗时，可能会有本体内部进水，导致产品故障的现象。请联系使用说明书上记载的服务热线。 | - |

规格

| | | 3.0L 型 | 4.0L 型 |
|----------|--------|----------------------|--------|
| 额定容量 | | 3.0L | 4.0L |
| 电压 | | AC 220-230V(50/60Hz) | |
| 消耗功率 | 烧水时的功率 | 682-745W | |
| | 保温时的功率 | 65-71W | |
| 外观尺寸*1*2 | 宽 | 21.2cm | |
| | 长 | 28.0cm | |
| | 高 | 29.4cm | 34.4cm |
| 重量*1*3 | | 2.3kg | 2.5kg |

*1 是大概数值。

*2 把手落下时的尺寸。

*3 包含电源线的重量

※ 在特定地域(高原、严寒地等)，规定的功能无法确保使用。

关于部品的购买及更换

请联系使用说明书上记载的服务热线。

上盖垫圈(易耗品)

以1年为标准进行确认, 如有以下问题请更换。
(以免翻倒有热水流出、引发烫伤。)

- 发白。
- 脏污或破损严重。
- 从上盖的缝隙中有蒸汽漏出。

| | |
|------|---------|
| 部品编号 | PDA1090 |
|------|---------|

树脂部品(有损伤时)

触及热气或蒸汽的树脂部品, 会随着使用有所损伤。请联系络虎牌特约服务点。

过滤网(易耗品)

过滤网安装在内容器的状态下进行柠檬酸清洗时, 都洗不掉污垢时。请更换。

| | |
|------|---------|
| 部品编号 | PVH1184 |
|------|---------|

上盖垫圈的更换方法

拆卸方法

将3颗螺丝
拧开。

将上盖垫
圈拆下。

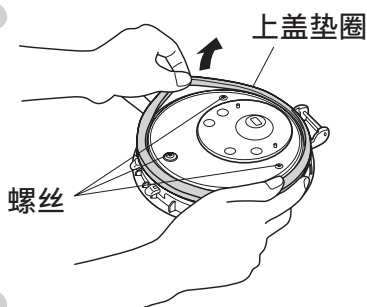

安装方法

新的上盖垫圈均匀的嵌入到栓内盖的外围。

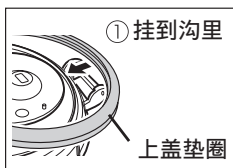
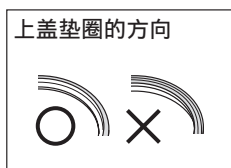

截面图

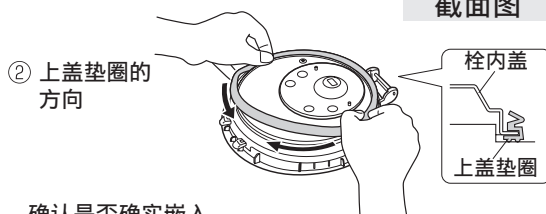

确认是否确实嵌入

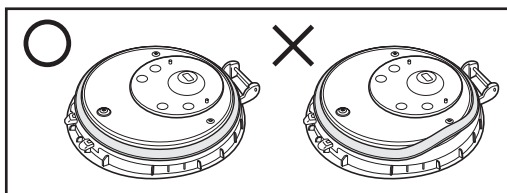

2 拧紧螺丝 (3颗)。

请注意

- ◆ 不要将栓内盖等部品从上盖取下来。以免导致蒸汽或开水漏出。如不慎拆下时, 请按照下图的顺序正确安装。

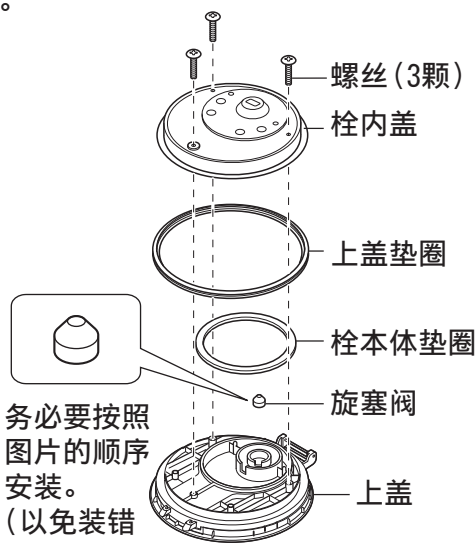

务必要按照图片的顺序安装。
(以免装错开水溢出, 造成烫伤)

因为除维修技术人员以外无法更换上盖内部的部件, 所以请联系使用说明书上记载的服务热线。



TIGER CORPORATION

Head Office:3-1 Hayamicho, Kadoma City, Osaka 571-8571, Japan

URL:<http://www.tiger.jp/global>